

CESSNA

"TAKE YOUR CESSNA HOME
FOR SERVICE AT THE SIGN
OF THE CESSNA SHIELD"



CESSNA AIRCRAFT COMPANY



WICHITA, KANSAS

CESSNA

MORE PEOPLE BUY AND
FLY CESSNA AIRPLANES
THAN ANY OTHER MAKE

1975

WORLD'S LARGEST PRO-
DUCER OF GENERAL
AVIATION AIRCRAFT
SINCE 1956

SKYWAGON 185



MODEL A185F

OWNER'S MANUAL

PERFORMANCE - SPECIFICATIONS

Skywagon 185 *

GROSS WEIGHT	3350 lbs
SPEED, BEST POWER MIXTURE:	
Top Speed at Sea Level	178 mph
Cruise, 75% Power at 7500 ft	169 mph
RANGE, EXTENDED RANGE MIXTURE:	
Cruise, 75% Power at 7500 ft	660 mi
62 Gallons, No Reserve	3.9 hrs
168 mph	
Cruise, 75% Power at 7500 ft	830 mi
78 Gallons, No Reserve	4.9 hrs
168 mph	
Maximum Range at 10,000 ft	825 mi
62 Gallons, No Reserve	6.4 hrs
129 mph	
Maximum Range at 10,000 ft	1035 mi
78 Gallons, No Reserve	8.0 hrs
129 mph	
RATE OF CLIMB AT SEA LEVEL	1010 fpm
SERVICE CEILING	17,150 ft
TAKE-OFF:	
Ground Run	770 ft
Total Distance Over 50-Foot Obstacle	1365 ft
LANDING:	
Ground Roll	480 ft
Total Distance Over 50-Foot Obstacle	1400 ft
STALL SPEEDS:	
Flaps Up, Power Off	65 mph
Flaps Down, Power Off	56 mph
EMPTY WEIGHT: One Seat (Approximate)	1600 lbs
USEFUL LOAD: (Approximate)	1750 lbs
WING LOADING: Pounds/Sq Foot	19.3
POWER LOADING: Pounds/HP	11.2
FUEL CAPACITY: Total	
Standard Tanks	65 gal.
Optional Long Range Tanks	84 gal.
OIL CAPACITY: Total	12 qts
PROPELLER: Constant Speed, Diameter	82 inches
ENGINE:	
Continental Fuel Injection Engine	IO-520-D
300 rated BHP at 2850 RPM (5-Minute Take-Off Rating)	
285 rated BHP at 2700 RPM (Maximum Continuous Rating)	

* This manual covers operation of the Skywagon 185 which is certificated as Model A185F under FAA Type Certificate No. 3A24

EFFECTIVE SERIALS 18502566 AND ON.

D1042-13-RPC-100-2/85

SERVICING REQUIREMENTS *

ENGINE OIL (CONTINUED):

the oil change interval may be extended to 100-hour intervals, providing the oil filter element is changed at 50-hour intervals. Change engine oil at least every 6 months even though less than the recommended hours have accumulated. Reduce intervals for prolonged operation in dusty areas, cold climates, or when short flights and long idle periods result in sludging conditions.

FUEL:

GRADE -- 100/130 Minimum Grade Aviation Fuel.

100/130 low lead aviation fuel with a lead content limited to 2 cc per gallon is also approved.

CAPACITY EACH STANDARD TANK -- 32.5 Gallons.

CAPACITY EACH LONG RANGE TANK -- 42.0 Gallons.

NOTE

With the "ON-OFF" fuel system, cross-feeding between fuel tanks may occur during fueling operations. Re-topping the tanks after each refueling will assure maximum capacity. If a "SELECTOR VALVE" fuel system is installed, place the fuel selector valve handle in the RIGHT or LEFT position while refueling to prevent cross-feeding and assure maximum capacity.

LANDING GEAR:

MAIN WHEEL TIRE PRESSURE -- 36 PSI on 6.00-6, 6-Ply Rated Tires
26 PSI on 8.00-6, 6-Ply Rated Tires

TAIL WHEEL TIRE PRESSURE -- 55 PSI to 70 PSI Max., 4-Ply Rated Tire
(2300 Lbs. to 3350 Lbs. Normal Operating Loads)

OXYGEN:

AVIATOR'S BREATHING OXYGEN -- Spec. No. MIL-O-27210

MAXIMUM PRESSURE (cylinder temperature stabilized after filling) --
1800 PSI at 70° F.

Refer to page 7-12 for filling pressures.

* For complete servicing requirements, refer to the aircraft Service Manual.

SERVICING REQUIREMENTS *

ENGINE OIL:

GRADE -- Aviation Grade SAE 50 Above 40°F.

Aviation Grade SAE 10W30 or SAE 30 Below 40°F.

Multi-viscosity oil with a range of SAE 10W30 is recommended for improved starting in cold weather. Ashless dispersant oil, conforming to Continental Motors Specification MHS-24A, must be used.

NOTE

Your Cessna was delivered from the factory with a corrosion preventive aircraft engine oil. If oil must be added during the first 25 hours, use only aviation grade straight mineral oil conforming to Specification No. MIL-L-6082.

CAPACITY OF ENGINE SUMP -- 12 Quarts.

Do not operate on less than 9 quarts. To minimize loss of oil through breather, fill to 10 quart level for normal flights of less than 3 hours. For extended flight, fill to 12 quarts. These quantities refer to oil dipstick level readings. During oil and oil filter changes, one additional quart is required when filter element is changed.

OIL DIPSTICK CALIBRATIONS

The oil dipstick is calibrated for both landplane and floatplane/amphibian use. Oil level readings for the floatplane/amphibian will register below the calibrations for the landplane due to the difference in attitude of the aircraft. When checking the oil level, take precautions to assure that you are using the correct calibrations for your airplane.

The landplane side of the dipstick is marked with four lines representing six, eight, ten and twelve quarts. The bottom line is the six quart level and the top line is the twelve quart (full) level. The floatplane/amphibian side of the dipstick has two x marks. The lower mark indicates nine quarts and the upper mark indicates twelve quarts.

OIL AND OIL FILTER CHANGE --

After first 25 hours of operation, drain engine oil sump and clean oil pressure screen. If optional oil filter is installed, change filter element at this time. Refill sump with straight mineral oil and use until a total of 50 hours has accumulated or oil consumption has stabilized; then change to dispersant oil. On aircraft not equipped with an optional oil filter, drain engine oil sump and clean oil pressure screen each 50 hours thereafter. On aircraft which have an optional oil filter,

CONGRATULATIONS

Welcome to the ranks of Cessna owners! Your Cessna has been designed and constructed to give you the most in performance, economy, and comfort. It is our desire that you will find flying it, either for business or pleasure, a pleasant and profitable experience.

This Owner's Manual has been prepared as a guide to help you get the most pleasure and utility from your Skywagon 185. It contains information about your Cessna's equipment, operating procedures, and performance; and suggestions for its servicing and care. We urge you to read it from cover to cover, and to refer to it frequently.

Our interest in your flying pleasure has not ceased with your purchase of a Cessna. World-wide, the Cessna Dealer Organization backed by the Cessna Service Department stands ready to serve you. The following services are offered by most Cessna Dealers:

THE CESSNA WARRANTY -- It is designed to provide you with the most comprehensive coverage possible:

- a. No exclusions
- b. Coverage includes parts and labor
- c. Available at Cessna Dealers world wide
- d. Best in the industry

Specific benefits and provisions of the warranty plus other important benefits for you are contained in your Customer Care Program book supplied with your aircraft. Warranty service is available to you at any authorized Cessna Dealer throughout the world upon presentation of your Customer Care Card which establishes your eligibility under the warranty.

FACTORY TRAINED PERSONNEL to provide you with courteous expert service.

FACTORY APPROVED SERVICE EQUIPMENT to provide you with the most efficient and accurate workmanship possible.

A STOCK OF GENUINE CESSNA SERVICE PARTS on hand when you need them.

THE LATEST AUTHORITATIVE INFORMATION FOR SERVICING CESSNA AIRPLANES, since Cessna Dealers have all of the Service Manuals and Parts Catalogs, kept current by Service Letters and Service News Letters, published by Cessna Aircraft Company.

We urge all Cessna owners to use the Cessna Dealer Organization to the fullest.

A current Cessna Dealer Directory accompanies your new airplane. The Directory is revised frequently, and a current copy can be obtained from your Cessna Dealer. Make your Directory one of your cross-country flight planning aids; a warm welcome awaits you at every Cessna Dealer.

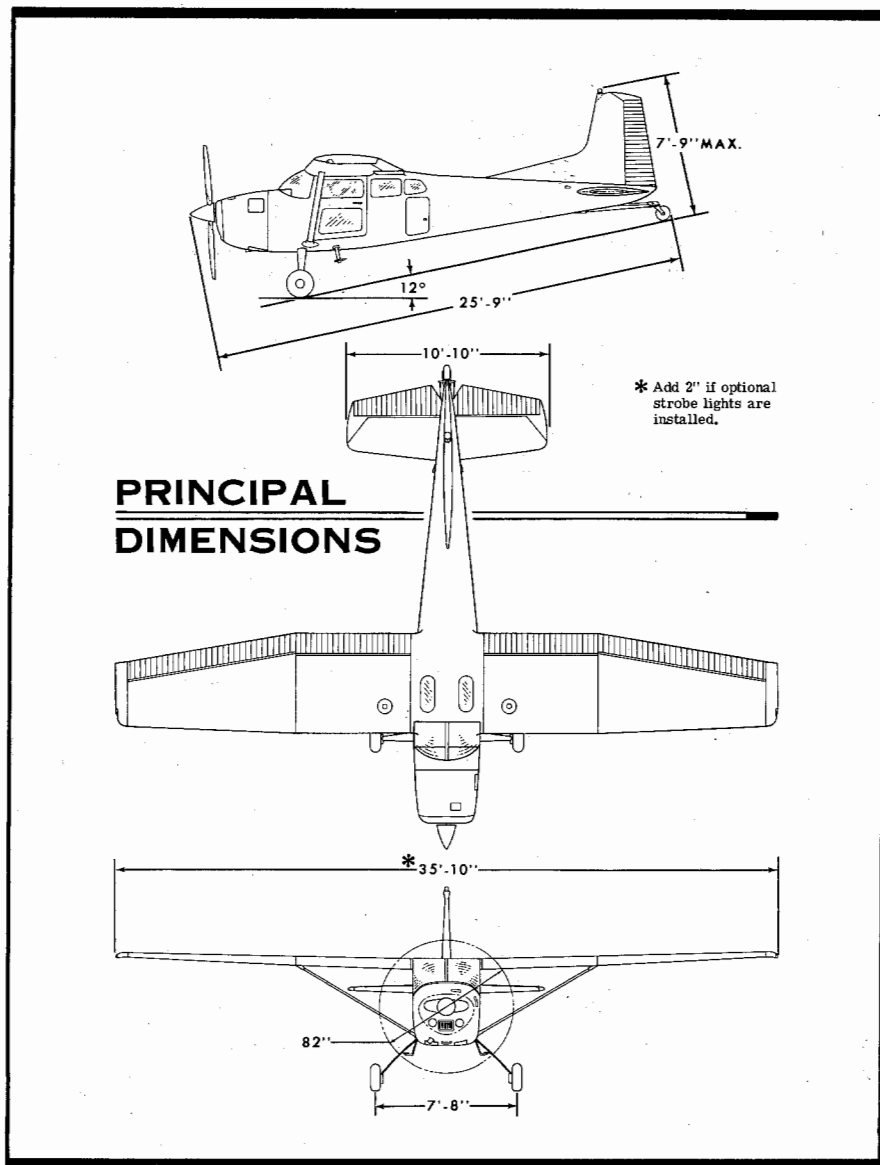

R

- Radio Selector Switches, 7-5
 - speaker-phone switches, 7-6
 - transmitter selector switch, 7-5
- Recovery From Spiral Dive, 3-5
- Removable Cabin Door, 2-13
- Rough Engine Operation Or Loss of Power, 3-7
 - engine-driven fuel pump failure, 3-8
 - low oil pressure, 3-8
 - magneto malfunction, 3-7
 - spark plug fouling, 3-7
- Rudder Pedals, Stowable, 7-14
- Rudder Pedal Extensions, 7-14

S

- Sample Loading Problem, 4-6
- Securing Aircraft, 1-7
- Servicing Requirements, 5-8, inside back cover
 - engine oil, inside back cover
 - fuel, inside back cover
 - landing gear, inside back cover
 - oxygen, inside back cover
- Shoulder Harnesses, 2-12, 2-13
- Spark Plug Fouling, 3-7
- Speaker-Phone Switches, 7-6
- Spins, 3-6
- Stalls, 2-20
 - speed chart, 6-2
- Starting Engine, 1-4; 2-14
- Static Dischargers, 7-7
- Static Pressure Alternate Source Valve, 7-4
- Storage, Flyable, 5-6
- Stowable Rudder Pedals, 7-14
- Suction Gage, 4-3

- Surfaces,
 - aluminum, 5-2
 - painted, 5-3

T

- Table of Contents, iii
- Tachometer, 4-3
- Tail Wheel Lock, Manual, 2-13, 2-15
- Take-Off, 1-5, 2-16
 - before, 1-5, 2-14
 - data chart, 6-3
 - maximum performance, 1-5
 - normal, 1-5
 - power check, 2-16
 - wing flap settings, 2-16
- Taxiing, 2-14
- Tire Pressure, inside back cover
- Transmitter Selector Switch, 7-5
- True Airspeed Indicator, 7-15

W

- Warm-Up, 2-15
- Weight,
 - empty, inside front cover
 - gross, inside front cover
- Weight and Balance, 4-4
 - baggage and cargo tie-down, 4-11
 - center of gravity moment envelope, 4-8
 - loading arrangements diagram, 4-9
 - sample loading problem, 4-6
- Windows, Observation, 7-15
- Windshield - Windows, 5-2
- Winterization Kit, 7-1

M

MAA Plate/Finish Trim Plate, 5-5
Magneto Check, 2-15
 malfunction, 3-7
Maneuvers - Normal Category, 4-1
Manual Tail Wheel Lock, 2-13,
 2-15
Manifold Pressure/Fuel Flow
 Indicator, 4-3
Markings, Airspeed Indicator, 4-2
Markings, Engine Instrument, 4-2
Master Switch, 2-8
Maximum Glide Diagram, 6-10
Maximum Performance Climb, 1-6
Maximum Performance Take-Off,
 1-5
Maximum Rate-Of-Climb Data
 Chart, 6-3
Microphone-Headset, 7-6
Moment Envelope, Center of
 Gravity, 4-8
Mooring Your Airplane, 5-1

N

Noise Abatement, 2-21
Non-Congeaing Oil Cooler, 7-1
Normal Category Maneuvers, 4-1
Normal Climb, 1-6
Normal Landing, 1-7
Normal Take-Off, 1-5

O

Observation Windows, 7-15
Oil System,
 capacity, inside back cover
 oil cooler, non-congealing,
 7-1

Index-4

oil dilution, 7-2
oil dilution table, 7-3
oil/filter change, inside back
 cover
oil grade, inside back cover
pressure gage, 4-3
quick-drain valve, 7-16
temperature gage, 4-3
Operation, Cold Weather, 2-20
Operation Limitations, Engine,
 4-2
Operations Authorized, 4-1
Over-Voltage Sensor and Warning
 Light, 2-7
Owner Follow-Up System, 5-9
 publications, 5-9
Oxygen System, 7-8
 duration calculations, 7-11
 duration chart, 7-9
 operation, 7-8
 servicing, 7-11, inside back
 cover

P

Pack, Cargo, 4-12, 7-13
Painted Surfaces, 5-3
Performance - Specifications,
 inside front cover
Precautionary Landing with Engine
 Power, 3-2
Primer System, Engine, 7-3
Principal Dimensions Diagram, ii
Progressive Care, Cessna 5-7
Propeller,
 care, 5-3
Publications, 5-9

Q

Quick-Drain Valve, Oil, 7-16

TABLE OF CONTENTS

	Page =
SECTION I - OPERATING CHECKLIST.....	1-1
SECTION II - DESCRIPTION AND OPERATING DETAILS	2-1
SECTION III - EMERGENCY PROCEDURES	3-1
SECTION IV - OPERATING LIMITATIONS.....	4-1
SECTION V - CARE OF THE AIRPLANE.....	5-1
SECTION VI - OPERATIONAL DATA.....	6-1
SECTION VII- OPTIONAL SYSTEMS.....	7-1
ALPHABETICAL INDEX.....	Index-1

REVISED FUEL QUANTITY DATA

SKYWAGON 185

1973 AIRCRAFT (SERIAL 18502263 AND ON)
1974 AIRCRAFT (ALL SERIALS)
1975 AIRCRAFT (ALL SERIALS)

Due to changes in fuel tank manufacturing technique, the fuel systems in the above noted airplanes have been found to contain less than the capacity published in the Owner's Manuals for landplanes and Owner's Manual Supplements for the AGcarryall or floatplanes, amphibians and skiplanes. Data in these manuals indicates total usable capacities of 59 gallons (standard tanks and "selector valve" fuel system), 78 gallons (long range tanks and "selector valve" fuel system), and 62 gallons (standard tanks and "on-off" fuel system). The usable capacity per tank in these systems is 29.5 gallons (standard tanks and "selector valve" system) and 39 gallons (long range tanks and "selector valve" system); in airplanes having standard tanks and an "on-off" system, single-tank operation is not selectable.

All fuel capacity references in Owner's Manuals and Supplements for these airplanes should be marked to reflect the capacities in the chart below.

	TOTAL BOTH TANKS	USABLE BOTH TANKS	TOTAL PER TANK	USABLE PER TANK
CAPACITY (STANDARD TANKS, SEL. VALVE SYS.)	61 Gal.	55 Gal.	30.5 Gal.	27.5 Gal.
CAPACITY (LONG RANGE TANKS, SEL. VALVE SYS.)	80 Gal.	74 Gal.	40 Gal.	37 Gal.
CAPACITY (STANDARD TANKS, ON-OFF SYSTEM)	61 Gal.	58 Gal.	30.5 Gal.	Not Selectable

When figuring weight and balance data, consideration should be given to the reduction in weight and change in moment/1000 which results from a reduced fuel capacity.

For quick re-computation of cruise performance data, use the information in the Cruise Performance charts provided in Owner's Manuals and Supplements by multiplying the ENDR. HOURS and RANGE MILES figures by 0.93 (for standard tank and "selector valve" or "on-off" system values) or 0.94 (for long range tank and "selector valve" system values); this will provide conservative endurance and range based on the reduced fuel capacities.

Pages in the Owner's Manuals or Supplements which are affected by the change in fuel capacity are listed in the chart below.

MANUAL	PAGES AFFECTED																		
	Inside Cover	2-1	2-14	4-6	4-7	5-8	6-4	6-5	6-6	6-7	6-8	7-1	7-2	Inside Cover	-	-	-	-	-
1973 OWNER'S MANUAL	Inside Cover	2-1	2-14	4-6	4-7	5-8	6-4	6-5	6-6	6-7	6-8	7-1	7-2	Inside Cover	-	-	-	-	-
1973 AGCARRYALL SUPPLEMENT	Inside Cover	3-4	3-5	5-3	5-4	-	-	-	-	-	-	-	-	-	-	-	-	-	-
1973 FLOAT, AMPHIB, SKI SUPPLEMENT	Inside Cover	1-9	1-10	1-15	1-16	1-17	1-18	1-19	2-13	2-14	2-20	2-21	2-22	2-23	2-24	3-7	3-8	3-9	3-10
1974 OWNER'S MANUAL	Inside Cover	2-1	2-3	2-4	2-5	2-17	4-6	4-7	6-4	6-5	6-6	6-7	6-8	Inside Cover	-	-	-	-	-
1974 AGCARRYALL SUPPLEMENT	Inside Cover	3-4	3-5	5-3	5-4	-	-	-	-	-	-	-	-	-	-	-	-	-	-
1974 FLOAT, AMPHIB, SKI SUPPLEMENT	Inside Cover	1-9	1-10	1-15	1-16	1-17	1-18	1-19	2-13	2-14	2-20	2-21	2-22	2-23	2-24	3-7	3-8	3-9	3-10
1975 OWNER'S MANUAL	Inside Cover	2-1	2-3	2-4	2-6	4-6	4-7	6-4	6-5	6-6	6-7	6-8	Inside Cover	-	-	-	-	-	-
1975 AGCARRYALL SUPPLEMENT	Inside Cover	3-4	3-5	5-3	5-4	-	-	-	-	-	-	-	-	-	-	-	-	-	-
1975 FLOAT, AMPHIB, SKI SUPPLEMENT	Inside Cover	1-9	1-10	1-15	1-16	1-17	1-18	1-19	2-13	2-14	2-20	2-21	2-22	2-23	2-24	3-7	3-8	3-9	3-10

precautionary landing with engine power, 3-2
Fuel Systems, 2-1
auxiliary fuel pump switch, 2-6
capacity, inside back cover
fuel flow indicator, 4-3
fuel grade, inside back cover
fuel quantity indicators, 4-2
long range fuel tanks, 2-6
"on-off", 2-1, 2-2
schematic, 2-2, 2-3
selector valve, 2-3, 2-4
tank sump and fuel quick-drain valves, 2-5
Fuses and Circuit Breakers, 2-9

Indicator, Fuel Quantity, 4-2
Indicator, True Airspeed, 7-15
Inspection Requirements, 5-6
Instrument Markings, Engine, 4-2
Instrument Panel Diagram, 1-8
Integrated Seat Belt/Shoulder Harnesses with Inertia Reels
Interior Care, 5-4
Interior Lighting, 2-10
Internal Cabin Dimensions Diagram, 4-10

L

Landing, 2-20
after, 1-7
balked, 1-7, 2-21
before, 1-6
distance table, 6-9
forced, 3-2
normal, 1-7
Landing Gear Servicing, inside back cover
main/tail wheel tire pressure, inside back cover
Leaning With A Cessna Economy Mixture Indicator (EGT), 2-19

G

Glide, Maximum, 6-10
Graph, Loading, 4-7
Gross Weight, inside front cover
Ground Handling, 5-1
Ground Service Plug Receptacle, 7-2

H

Handling, Ground, 5-1
Harnesses, Shoulder, 2-12, 2-13
Headset-Microphone, 7-6
Heating, Ventilating and Defrosting System, Cabin, 2-11

Let-Down, 1-6
Lighting Equipment, 2-9
exterior lighting, 2-9
interior lighting, 2-10
Limitations, Airspeed, 4-2
Limitations, Engine Operation, 4-2
Loading Arrangements Diagram, 4-9
Loading, Cargo, 4-11
Loading Graph, 4-7
Loading Problem, Sample, 4-6
Long Range Fuel Tanks, 2-6
Low Oil Pressure, 3-8

I

Indicator, Fuel Flow, 4-3

OPERATING CHECKLIST

One of the first steps in obtaining the utmost performance, service, and flying enjoyment from your Cessna is to familiarize yourself with your aircraft's equipment, systems, and controls. This can best be done by reviewing this equipment while sitting in the aircraft. Those items whose function and operation are not obvious are covered in Section II.

Section I lists, in Pilot's Checklist form, the steps necessary to operate your aircraft efficiently and safely. It is not a checklist in its true form as it is considerably longer, but it does cover briefly all of the points that you should know for a typical flight. A more convenient plastic enclosed checklist, stowed in the map compartment, is available for quickly checking that all important procedures have been performed. Since vigilance for other traffic is so important in crowded terminal areas, it is important that preoccupation with checklists be avoided in flight. Procedures should be carefully memorized and performed from memory. Then the checklist should be quickly scanned to ensure that nothing has been missed.

The flight and operational characteristics of your aircraft are normal in all respects. There are no "unconventional" characteristics or operations that need to be mastered. All controls respond in the normal way within the entire range of operation. All airspeeds mentioned in Sections I, II and III are indicated airspeeds. Corresponding calibrated airspeed may be obtained from the Airspeed Correction Table in Section VI.

D

- Diagram,
 - cargo loading, 4-11
 - cargo pack, 4-12
 - electrical system, 2-8
 - exterior inspection, 1-2
 - fuel system, 2-2, 2-3
 - instrument panel, 1-8
 - internal cabin dimensions, 4-10
 - loading arrangements, 4-9
 - maximum glide, 6-10
 - principal dimensions, ii
 - radio selector switches, 7-5
- Dimensions, Internal Cabin, 4-10
- Dimensions, Principal, ii
- Disorientation In Clouds, 3-4
 - emergency let-downs through clouds, 3-5
 - executing 180° turn in clouds, 3-4
 - recovery from spiral dive, 3-5
- Ditching, 3-3

E

- Economy Mixture Indicator, 2-19
- Electric Fire in Flight, 3-3
- Electrical Power Supply System
 - Malfunctions, 3-8
 - excessive rate of charge, 3-9
 - insufficient rate of charge, 3-9
- Electrical System, 2-7
 - ammeter, 2-7
 - circuit breakers and fuses, 2-9
 - ground service plug receptacle, 7-2
 - master switch, 2-7
 - over-voltage sensor and warning light, 2-7
 - schematic, 2-8
- Emergency Landing Without Engine Power, 3-2

- Emergency Let-Downs Through Clouds, 3-5
- Emergency Locator Transmitter (ELT), 3-10
 - ELT control panel, 3-10
 - ELT operation, 3-11
- Empty Weight, inside front cover
- Engine,
 - before starting, 1-4
 - instrument markings, 4-2
 - oil, inside back cover
 - operation limitations, 4-2
 - primer system, 7-3
 - starting, 1-4, 2-14
- Engine Failure, 3-1
 - after take-off, 3-1
 - during flight, 3-1
- Enroute Climb, 1-6, 2-17
 - maximum performance, 1-6
 - normal, 1-6
- Engine-Driven Fuel Pump Failure, 3-8
- Equipment, Cold Weather, 7-1
- Excessive Rate of Electrical Charge, 3-9
- Executing 180° Turn in Clouds, 3-4
- Exterior Care, 5-2
- Exterior Inspection Diagram, 1-2
- Exterior Lighting, 2-9

F

- File, Aircraft, 5-5
- Fires, 3-3
 - electrical fire in flight, 3-3
 - engine fire in flight, 3-3
- Flight in Icing Conditions, 3-6
- Flyable Storage, 5-6
- Forced Landings, 3-2
 - ditching, 3-3
 - emergency landing without engine power, 3-2

ALPHABETICAL INDEX

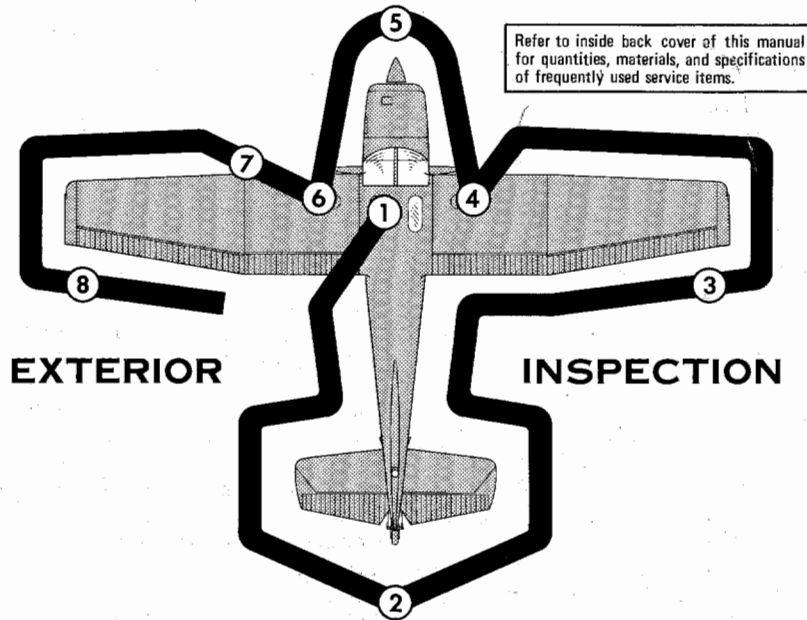

Refer to inside back cover of this manual for quantities, materials, and specifications of frequently used service items.

EXTERIOR

INSPECTION

Note

Visually check aircraft for general condition during walk-around inspection. In cold weather, remove even small accumulations of frost, ice or snow from wing, tail and control surfaces. Also, make sure that control surfaces contain no internal accumulations of ice or debris. If a night flight is planned, check operation of all lights, and make sure a flashlight is available.

- ①
 - a. Remove control wheel lock.
 - b. Check ignition switch OFF.
 - c. Turn on master switch and check fuel quantity indicators; then turn off master switch.
 - d. Check fuel shutoff valve knob ON (full in). If optional fuel tank selector valve is installed, check that handle is in BOTH ON position.
 - e. Check baggage door securely locked.
- ②
 - a. Remove rudder gust lock, if installed.
 - b. Disconnect tail tie-down.

Figure

A

Aft Baggage Compartment 2-13
 After Landing, 1-7
 Aircraft,
 file, 5-5
 securing, 1-7
 Airspeed Correction Table, 6-1
 Airspeed Indicator, True, 7-15
 Airspeed Indicator Markings, 4-2
 Airspeed Limitations, 4-2
 Alternate Source Valve, Static
 Pressure, 7-4
 Alternator Check, 2-15
 Aluminum Surfaces, 5-2
 Ammeter, 2-7
 Authorized Operations, 4-1
 Auxiliary Fuel Pump Switch, 2-7

B

Baggage Compartment, Aft, 2-13
 Bailed Landing, 1-7, 2-21
 Before Landing, 1-6
 Before Starting Engine, 1-4
 Before Take-Off, 1-5, 2-14
 alternator check, 2-15
 magneto check, 2-15
 warm-up, 2-15

C

Cabin Door, Removable, 2-13
 Cabin Heating, Ventilating and
 Defrosting System, 2-11
 Capacity,

fuel, inside back cover
 oil, inside back cover
 Care,
 exterior, 5-2
 interior, 5-4
 propeller, 5-3
 Cargo Loading, 4-11
 Cargo Pack, 4-12, 7-13
 flight operation, 7-13
 speed differential table, 7-13
 Center of Gravity Moment
 Envelope, 4-8
 Cessna Customer Care Program,
 5-7
 Cessna Progressive Care, 5-7
 Circuit Breakers and Fuses, 2-9
 Climb,
 enroute, 1-6, 2-17
 maximum rate-of-climb
 data chart, 6-3
 maximum performance, 1-6
 normal, 1-6
 Cold Weather Equipment, 7-1
 engine primer system, 7-3
 ground service plug
 receptacle, 7-2
 non-congealing oil cooler, 7-1
 oil dilution system, 7-2
 static pressure alternate
 source valve, 7-4
 winterization kit, 7-1
 Cold Weather Operation, 2-21
 Correction Table, Airspeed, 6-1
 Cruise Performance Chart, 2-18,
 6-4, 6-5, 6-6, 6-7, 6-8
 Cruise, 1-6, 2-17
 leaning with EGT, 2-19
 Cylinder Head Temperature Gage,
 4-3

CESSNA ECONOMY MIXTURE INDICATOR

The Cessna Economy Mixture Indicator is an exhaust gas temperature (EGT) sensing device which visually aids the pilot in adjusting the cruise mixture. Exhaust gas temperature varies with fuel-to-air ratio, power and RPM. However, the difference between the peak EGT and the EGT at the cruise mixture setting is essentially constant and this provides a useful leaning aid. Operating instructions are included in Section II.

OIL QUICK-DRAIN VALVE

An optional oil quick-drain system is offered to facilitate draining the engine oil sump by eliminating the need for removal of the lower cowling. The system consists of a hose from the engine sump to an on-off valve (spring-loaded in the off position) located on the lower left side of the engine mount. The valve handle is accessible through the opening at the bottom of the lower cowling. Rotating the handle clockwise will open the valve.

- c. Check tail wheel tire for proper inflation.
- d. Check control surfaces for freedom of movement and security.

③ a. Check aileron for free and correct movement and security.

- ④
- a. Disconnect wing tie-down.
 - b. Check fuel tank vent opening for stoppage.
 - c. Check main wheel tire for proper inflation.
 - d. Before first flight of day and after each refueling, use sampler cup and drain small quantity of fuel from fuel tank sump quick-drain valve to check for water, sediment, and proper fuel grade.
 - e. Use sampler cup and drain small quantity of fuel from fuel line quick-drain valve located on the bottom of the fuselage below the cabin door.
 - f. Visually check fuel quantity; then check fuel filler cap secure and vent unobstructed.

- ⑤
- a. Inspect flight instrument static source opening on side of fuselage for stoppage (both sides).
 - b. Check propeller and spinner for nicks and security, and propeller for oil leaks.
 - c. Check induction air filter for restrictions by dust or other foreign matter.
 - d. Check oil level. Do not operate with less than nine quarts. Fill to twelve quarts for extended flight.
 - e. Before first flight of the day and after each refueling, pull out strainer drain knob for about four seconds to clear fuel strainer of possible water and sediment. Check strainer drain closed. If water is observed, the fuel system may contain additional water, and further draining of the system at the strainer, fuel tank sumps, and fuel line drain valves will be necessary.

- ⑥
- a. Visually check fuel quantity; then check fuel filler cap secure and vent unobstructed.
 - b. Check main wheel tire for proper inflation.
 - c. Before first flight of day and after each refueling, use sampler cup and drain small quantity of fuel from fuel tank sump quick-drain valve to check for water, sediment, and proper fuel grade.
 - d. Use sampler cup and drain small quantity of fuel from fuel line quick-drain valve located on the bottom of the fuselage below the cabin door.
 - e. Remove pitot tube cover, if installed, and check pitot tube opening for stoppage.

- ⑦
- a. Check stall warning vent opening for stoppage.
 - b. Check fuel tank vent opening for stoppage.
 - c. Disconnect wing tie-down.

- ⑧ a. Check aileron for free and correct movement and security.

1-1.

BEFORE STARTING ENGINE.

- (1) Exterior Preflight -- COMPLETE.
- (2) Seats, Belts, Shoulder Harnesses -- ADJUST and LOCK.
- (3) Fuel Shutoff Valve -- ON.
- (4) Fuel Selector Valve (if installed) -- BOTH ON.
- (5) Brakes -- TEST and SET.
- (6) Radios, Autopilot, Electrical Equipment -- OFF.
- (7) Wing Flaps -- CHECK ALL POSITIONS.
- (8) Cowl Flaps -- OPEN (move lever out of locking detent to reposition).
- (9) Tail Wheel Lock -- UNLOCK.

STARTING ENGINE.

- (1) Master Switch -- ON.
- (2) Mixture -- RICH.
- (3) Propeller -- HIGH RPM.
- (4) Throttle -- CLOSED.
- (5) Auxiliary Fuel Pump -- ON.
- (6) Throttle -- ADVANCE for 8-10 GPH; then RETARD to IDLE.
- (7) Auxiliary Fuel Pump -- OFF.
- (8) Propeller Area -- CLEAR.
- (9) Ignition Switch -- START.
- (10) Throttle -- ADVANCE slowly.
- (11) Ignition Switch -- RELEASE when engine starts.

NOTE

The engine should start in two to three revolutions. If it does not continue running, start again at step (4) above. If the engine does not start, leave auxiliary fuel pump switch off, set mixture to idle cut-off, open throttle, and crank until engine fires or for approximately 15 seconds. If still unsuccessful, start again using the normal starting procedure after allowing the starter motor to cool.

- (12) Throttle -- IDLE.
- (13) Oil Pressure -- CHECK.

NOTE

If oil pressure is not indicated within 30 seconds in normal temperatures and 60 seconds in cold temperatures, shut off engine and investigate the cause.

OBSERVATION WINDOWS

Special windows are available to increase the area of visibility for the pilot and copilot. Two windows in the cabin roof provide visibility above the aircraft. Two additional windows in the lower portion of the cabin doors increase visibility below and to each side of the aircraft. A pair of domed windows, which replace the standard flat windows in the cabin doors, permit a line of vision beyond the side of the fuselage to provide almost vertical observation of the area beneath the aircraft. Each openable domed window is held in the closed position by two over-center latches equipped with push-button locks which must be depressed before the latch can be released. The windows may be opened below 120 MPH, as indicated by a placard just below the lower forward corner of the left window.

TRUE AIRSPEED INDICATOR

A true airspeed indicator is available to replace the standard airspeed indicator in your airplane. The true airspeed indicator has a calibrated rotatable ring which works in conjunction with the airspeed indicator dial in a manner similar to the operation of a flight computer.

TO OBTAIN TRUE AIRSPEED, rotate ring until pressure altitude is aligned with outside air temperature in degrees Fahrenheit. Then read true airspeed on rotatable ring opposite airspeed needle.

NOTE

Pressure altitude should not be confused with indicated altitude. To obtain pressure altitude, set barometric scale on altimeter to 29.92 and read pressure altitude on altimeter. Be sure to return altimeter barometric scale to original barometric setting after pressure altitude has been obtained.

STOWABLE RUDDER PEDALS

Stowable right-hand rudder pedals are available as part of the optional right-hand flight controls installation. The pedals fold forward and stow against the firewall, thereby permitting the right front passenger to extend his feet forward for greater comfort, and also to rest his feet on the rudder pedals during flight without, in any way, interfering with the flight operation of the pilot's rudder pedals.

A push-pull control on the instrument panel actuates the pedal unlocking mechanism. The pedals are stowed simply by squeezing the double buttons of the control knob and pulling the knob out to release the pedals; the pedals can then be pushed forward against the firewall where they are retained by spring clips within a bracket. The pedals are restored to their operating positions by pushing the control knob full in, and inserting the toe of the shoe underneath each pedal and pulling each pedal aft until it snaps into position. The pedals are again ready for flight use by the right front passenger.

RUDDER PEDAL EXTENSIONS

Rudder pedal extensions are available as optional equipment for use on either the pilot's or copilot's rudder pedals. The extensions allow the user to position his seat approximately one and one half inches aft of his normal seat position, primarily for improved visibility through the optional domed observation window in the cabin door.

A standard rudder pedal face, two spacer blocks, and two clips comprise the rudder pedal extension assembly. The extensions are easily installed by hooking the clip on the bottom of the extension under the bottom of the rudder pedal, and then pressing the top clip over the top of the rudder pedal. Removal is accomplished by grasping the top clip and lifting it up and over the rudder pedal, allowing the extension to fall free.

BEFORE TAKE-OFF.

- (1) Parking Brake -- SET.
- (2) Fuel Selector Valve (if installed) -- BOTH ON.
- (3) Flight Controls -- FREE and CORRECT.
- (4) Stabilizer and Rudder Trim -- SET.
- (5) Cowl Flaps -- OPEN.
- (6) Throttle -- 1700 RPM.
 - a. Magnetos -- CHECK (RPM drop should not exceed 150 RPM on either magneto or 50 RPM differential between magnetos).
 - b. Propeller -- CYCLE from high to low RPM; return to high RPM (full in).
 - c. Engine Instruments -- CHECK.
 - d. Suction -- CHECK (4.6 to 5.4 In. Hg.).
 - e. Ammeter -- CHECK.
- (7) Flight Instruments and Radios -- CHECK and SET.
- (8) Cabin Doors -- CLOSED and LOCKED.
- (9) Tail Wheel Lock -- AS DESIRED.
- (10) Parking Brake -- RELEASE.
- (11) Throttle Friction Lock -- ADJUST.
- (12) Wing Flaps -- 0°-20°.

TAKE-OFF.

NORMAL TAKE-OFF.

- (1) Wing Flaps -- 0°-20°.
- (2) Power -- FULL THROTTLE and 2850 RPM.
- (3) Elevator Control -- MODERATELY TAIL LOW.
- (4) Climb Speed -- 100 MPH.
- (5) Wing Flaps -- UP after obstacles are cleared.

MAXIMUM PERFORMANCE TAKE-OFF.

- (1) Wing Flaps -- 20°.
- (2) Brakes -- APPLY.
- (3) Power -- FULL THROTTLE and 2850 RPM.
- (4) Mixture -- LEAN FOR FIELD ELEVATION.
- (5) Brakes -- RELEASE.

- (6) Elevator Control -- MAINTAIN TAIL LOW.
- (7) Climb Speed -- 64 MPH (until all obstacles are cleared).
- (8) Wing Flaps -- UP after obstacles are cleared.

ENROUTE CLIMB.

NORMAL CLIMB.

- (1) Airspeed -- 110-120 MPH.
- (2) Power -- 25 INCHES Hg. and 2550 RPM.
- (3) Mixture -- LEAN FOR ALTITUDE AS NECESSARY.
- (4) Cowl Flaps -- AS REQUIRED.

MAXIMUM PERFORMANCE CLIMB.

- (1) Airspeed -- 101 MPH (sea level) to 94 MPH (10,000 feet).
- (2) Power -- FULL THROTTLE and 2700 RPM.
- (3) Mixture -- LEAN FOR ALTITUDE.
- (4) Cowl Flaps -- OPEN.

CRUISE.

- (1) Power -- 15-25 INCHES Hg. , 2200-2550 RPM (no more than 75%).
- (2) Cowl Flaps -- AS REQUIRED.
- (3) Stabilizer and Rudder Trim -- ADJUST.
- (4) Mixture -- LEAN for cruise as determined from your Cessna Power Computer, or in accordance with the Cruise procedures in Section II.

LET-DOWN.

- (1) Mixture -- ENRICHEN (as required).
- (2) Power -- AS DESIRED.
- (3) Cowl Flaps -- CLOSED.

BEFORE LANDING.

- (1) Mixture -- RICH.
- (2) Fuel Selector Valve (if installed) -- BOTH ON.
- (3) Cowl Flaps -- CLOSED.

CARGO PACK

FLIGHT OPERATION WITH A CARGO PACK.

All flight characteristics for a cargo pack equipped aircraft are identical to an aircraft without a cargo pack. There is, however, a slight climb and cruise performance differential between the two aircraft.

The climb performance of the aircraft equipped with a cargo pack is approximately 40 ft/min less than that shown in the MAXIMUM RATE-OF-CLIMB DATA table for the standard airplane.

To obtain the speed performance for the aircraft equipped with a cargo pack, the speed differentials shown in the table below should be subtracted from the TAS MPH figures shown in the CRUISE PERFORMANCE tables for the standard airplane. Cruising range is computed by multiplying the cargo pack TAS by the endurance.

For cargo loading, refer to Section IV.

SPEED DIFFERENTIAL TABLE

% BHP	SPEED DIFFERENTIAL MPH
75	-7
65	-8
55	-9
45	-9

Figure 7-4.

AMBIENT TEMPERATURE °F	FILLING PRESSURE PSIG	AMBIENT TEMPERATURE °F	FILLING PRESSURE PSIG
0	1600	50	1825
10	1650	60	1875
20	1700	70	1925
30	1725	80	1975
40	1775	90	2000

pression of the oxygen. Because of this, merely filling to 1800 psi will not result in a properly filled cylinder. Fill to the pressures indicated in the table above for the ambient temperature.

IMPORTANT

Oil, grease, or other lubricants in contact with oxygen create a serious fire hazard, and such contact must be avoided when handling oxygen equipment.

- (4) Propeller -- HIGH RPM.
- (5) Airspeed -- 85-95 MPH (flaps UP).
- (6) Wing Flaps -- 0° - 40° (below 110 MPH).
- (7) Airspeed -- 75-85 MPH (flaps DOWN).
- (8) Stabilizer and Rudder Trim -- ADJUST FOR LANDING.

NOTE

The ability of the aircraft to land three-point is dependent upon the stabilizer being adjusted for hands-off trim in the glide.

- (9) Tail Wheel Lock -- AS DESIRED.

BALKED LANDING.

- (1) Power -- FULL THROTTLE and 2850 RPM.
- (2) Wing Flaps -- RETRACT TO 20°.
- (3) Airspeed -- 80 MPH.
- (4) Wing Flaps -- RETRACT slowly.
- (5) Cowl Flaps -- OPEN.

NORMAL LANDING.

- (1) Landing Technique -- Conventional for all flap settings.

AFTER LANDING.

- (1) Wing Flaps -- UP.
- (2) Tail Wheel Lock -- UNLOCK.
- (3) Cowl Flaps -- OPEN.
- (4) Stabilizer and Rudder Trim -- SET FOR TAKE-OFF.

SECURING AIRCRAFT.

- (1) Parking Brake -- SET.
- (2) Radios, Electrical Equipment -- OFF.
- (3) Mixture -- IDLE CUT-OFF.
- (4) Ignition Switch -- OFF.
- (5) Master Switch -- OFF.
- (6) Control Lock -- INSTALLED.

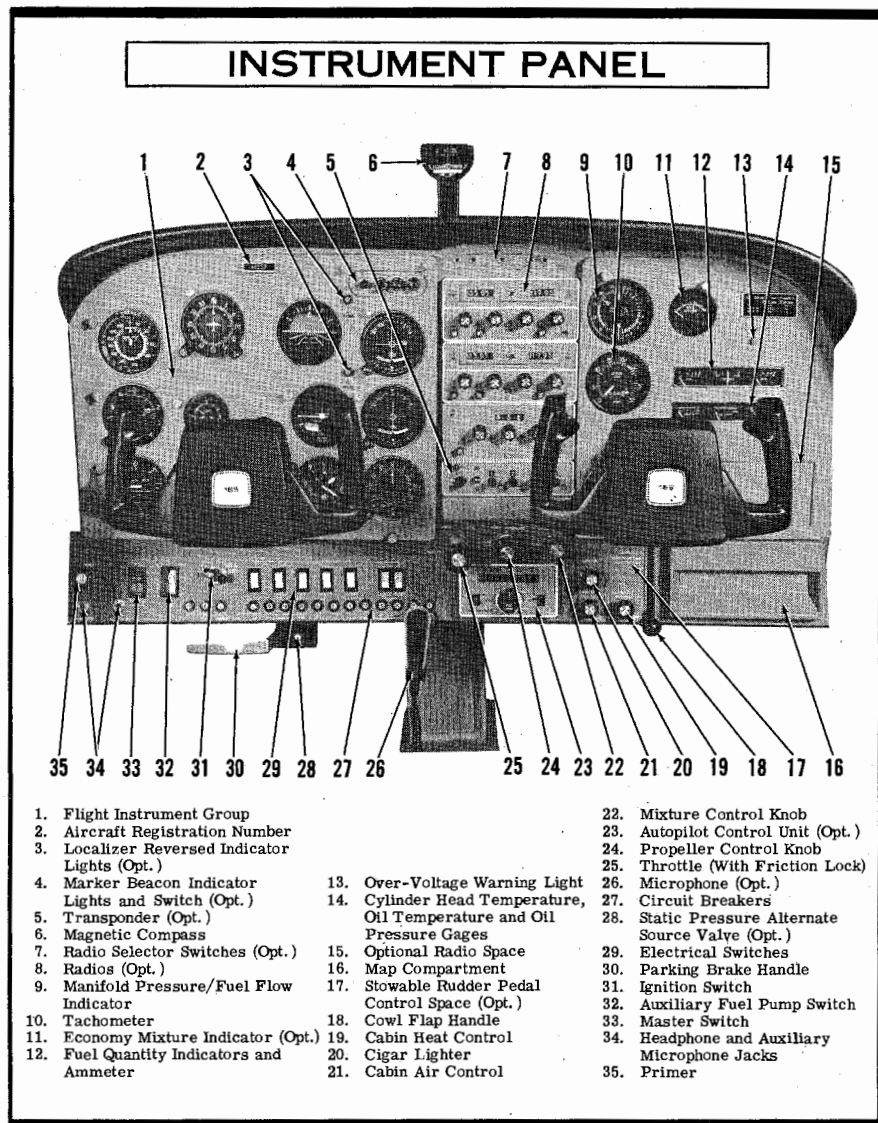

Figure 2-1.

(6) Unplug the delivery hose from the outlet coupling when discontinuing use of the oxygen system. This automatically stops the flow of oxygen.

(7) Position oxygen supply control knob OFF.

OXYGEN DURATION CALCULATION.

The Oxygen Duration Chart (figure 7-3) should be used in determining the usable duration (in hours) of the oxygen supply in your airplane. The following procedure outlines the method of finding the duration from the chart.

(1) Note the available oxygen pressure shown on the pressure gage.

(2) Locate this pressure on the scale on the left side of the chart, then go across the chart horizontally to the right until you intersect the line representing the number of persons making the flight. After intersecting the line, drop down vertically to the bottom of the chart and read the duration in hours given on the scale.

(3) As an example of the above procedure, 1400 psi of pressure will safely sustain the pilot only for nearly 6 hours and 15 minutes. The same pressure will sustain the pilot and three passengers for approximately 2 hours and 30 minutes.

NOTE

The Oxygen Duration Chart is based on a standard configuration oxygen system having one orange color-coded hose assembly for the pilot and green color-coded hoses for the passengers. If orange color-coded hoses are provided for pilot and passengers, it will be necessary to compute new oxygen duration figures due to the greater consumption of oxygen with these hoses. This is accomplished by computing the total duration available to the pilot only (from PILOT ONLY line on chart), then dividing this duration by the number of persons (pilot and passengers) using oxygen.

OXYGEN SYSTEM SERVICING.

The oxygen cylinder, when fully charged, contains approximately 48 cubic feet of oxygen, under a pressure of 1800 psi at 70°F. Filling pressures will vary, however, due to the ambient temperature in the filling area, and because of the temperature rise resulting from com-

or alcohol will usually necessitate the use of oxygen at less than 10,000 feet.

NOTE

For safety reasons, no smoking should be allowed in the aircraft while oxygen is being used.

When ready to use the oxygen system, proceed as follows:

- (1) Select mask and hose.

NOTE

The hose provided for the pilot is of a higher flow rate than those for the passengers; it is color-coded with an orange band adjacent to the plug-in fitting. The passenger hoses are color-coded with a green band. If the aircraft owner prefers, he may provide higher flow hoses for all passengers. In any case, it is recommended that the pilot use the larger capacity hose. The pilot's mask is equipped with a microphone to facilitate use of the radio while using oxygen. An adapter cord is furnished with the microphone-equipped mask to mate the mask microphone lead to the AUX MIKE JACK located on the left side of the instrument panel. To connect the oxygen mask microphone, connect the mask lead to the adapter cord and plug the cord into the AUX MIKE JACK. (If an optional microphone-headset combination has been in use, the microphone lead from this equipment is already plugged into the AUX MIKE JACK. It will be necessary to disconnect this lead from the AUX MIKE JACK so that the adapter cord from the oxygen mask microphone can be plugged into the jack.) A switch is incorporated on the left hand control wheel to operate the microphone.

- (2) Attach mask to face and adjust metallic nose strap for snug mask fit.
- (3) Select oxygen outlet located nearest to the seat you are occupying, and plug delivery hose into it. When the oxygen supply is turned on, oxygen will flow continuously at the proper rate of flow for any altitude without any manual adjustments.
- (4) Position oxygen supply control knob ON.
- (5) Check the flow indicator in the face mask hose. Oxygen is flowing if the indicator is being forced toward the mask.

Section II

DESCRIPTION AND OPERATING DETAILS

The following paragraphs describe the systems and equipment whose function and operation is not obvious when sitting in the aircraft. This section also covers in somewhat greater detail some of the items listed in Checklist form in Section I that require further explanation.

FUEL SYSTEMS.

The aircraft contains, as standard equipment, an "ON-OFF" fuel shutoff valve system. An optional selector valve system which provides fuel tank selection capability is also available. Details of both systems are discussed in the following paragraphs. Optional long range fuel tanks are also available.

"ON-OFF" FUEL SYSTEM.

Fuel is supplied to the engine from two tanks, one in each wing. The total usable fuel, for all flight conditions, is 62 gallons.

Fuel from each wing tank flows by gravity through a fuel accumulator tank, shutoff valve, fuel strainer, by-pass in the electric auxiliary fuel pump (when it is not operating) and engine-driven fuel pump to the cylinders via a fuel control unit and manifold. Vapor and excess fuel from the engine-driven fuel pump and fuel control unit are returned to the main fuel tanks by way of the fuel accumulator tank.

To provide fuel flow to the engine, squeeze together the double buttons of the fuel shutoff valve control knob (located on the floor console), releasing the lock, and push the knob full in. Fuel will flow from both wing fuel tanks simultaneously.

NOTE

With full fuel, the tanks may not drain evenly because fuel may be sloshed into the interconnect vent line, preventing absolutely equal vent pressures in each

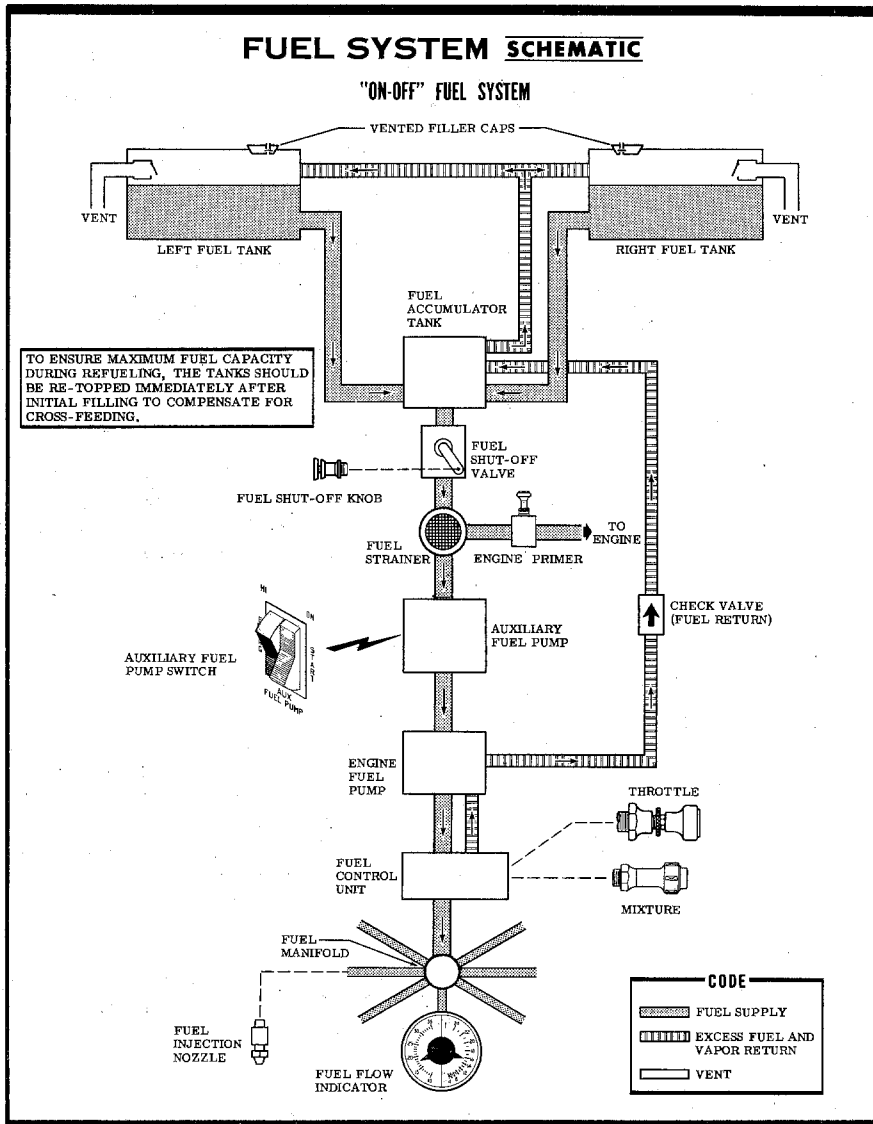

Figure 2-2.

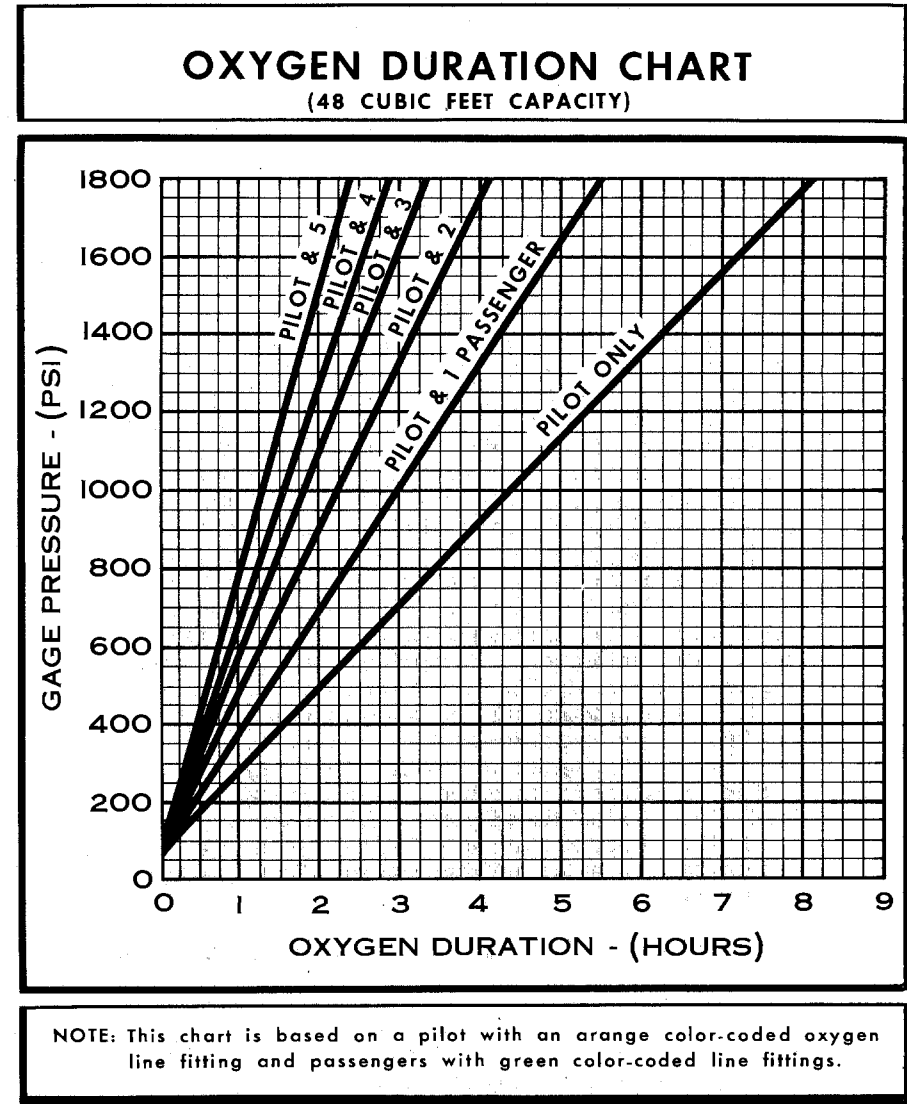

Figure 7-3.

OXYGEN SYSTEM

A six-place oxygen system is available for this aircraft. In this system, an oxygen cylinder, located behind the rear cabin wall, supplies the oxygen. Cylinder pressure is reduced to an operating pressure of 70 psi by a pressure regulator attached to the cylinder. A shutoff valve is included as part of the regulator assembly. An oxygen cylinder filler valve is located on the left side of the fuselage aft of the cabin side windows under a round cover plate. Cylinder pressure is indicated by a pressure gage located on the rear cabin wall.

Six oxygen outlets are provided; two outlets for the aft seat passengers are located on the rear wall adjacent to the pressure gage, two are in the cabin ceiling for the center seat passengers, and one each is located on each side of the cabin in the wing root area for use by the pilot and front seat passenger. One permanent, microphone equipped mask is provided for the pilot, and five disposable type masks are provided for the passengers. All masks are the partial rebreathing type, equipped with vinyl plastic hoses and flow indicators.

A remote shutoff valve control, located adjacent to the pilot's oxygen outlet, is used to shut off the supply of oxygen to the system when not in use. The control is mechanically connected to the shutoff valve at the cylinder. With the exception of the shutoff function, the system is completely automatic and requires no manual regulation for change of altitude.

OXYGEN SYSTEM OPERATION.

Prior to flight, check to be sure that there is an adequate oxygen supply for the trip, by noting the oxygen pressure gage reading. Refer to paragraph OXYGEN DURATION CALCULATION and to the Oxygen Duration Chart (figure 7-3). Also, check that the face masks and hoses are accessible and in good condition.

Supplemental oxygen should be used by all occupants when cruising above 10,000 feet. As described in the Cessna booklet "Man At Altitude," it is often advisable to use oxygen at altitudes lower than 10,000 feet under conditions of night flying, fatigue, or periods of physiological or emotional disturbances. Also, the habitual and excessive use of tobacco

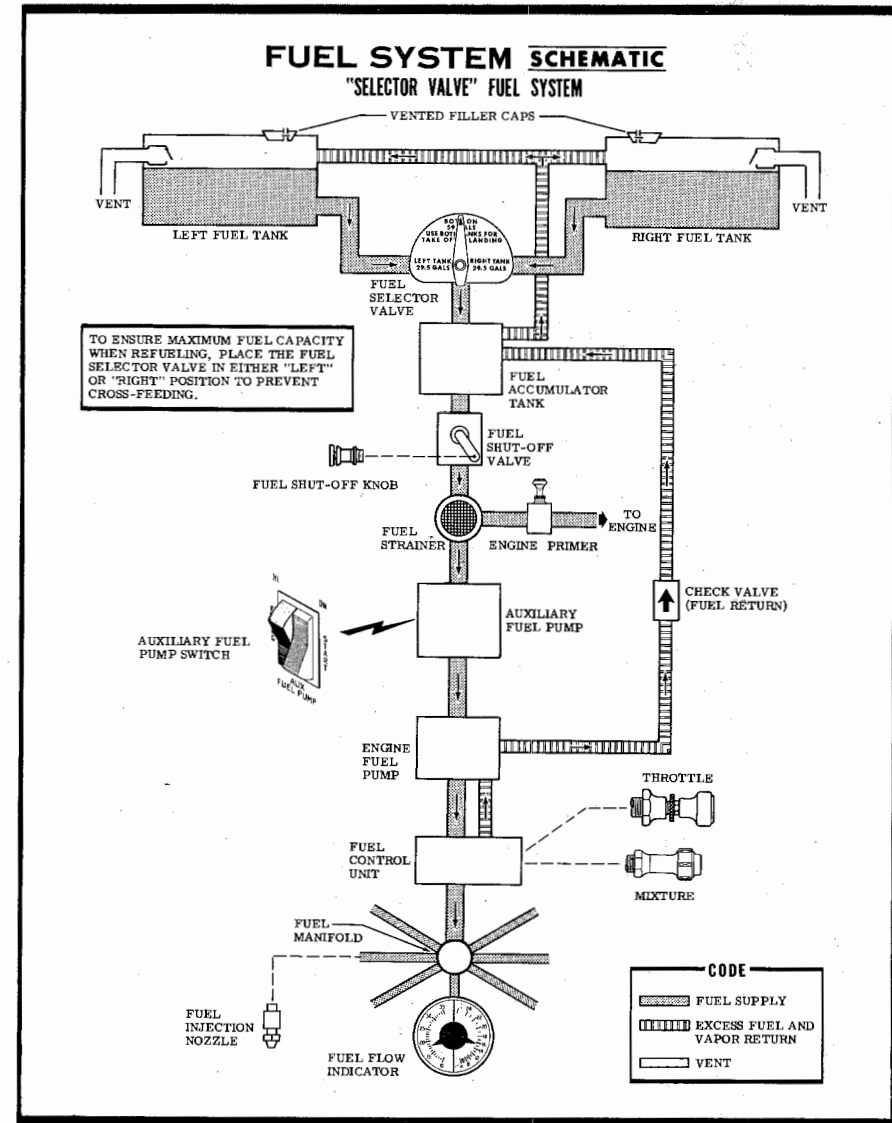

Figure 2-3.

tank. However, as fuel is consumed, clearing the interconnect vent line and equalizing tank vent pressures, the fuel quantities should equalize in each tank, provided the wings are maintained exactly level.

When the control knob is pulled full out, the shutoff valve is closed, isolating the wing tanks and fuel accumulator tank from the engine.

"SELECTOR VALVE" FUEL SYSTEM (OPT).

A "selector valve" fuel system is available to provide fuel tank selection capability. The system is standard with long range fuel tanks and optional with standard range tanks. When this system is installed, the total usable fuel, for all flight conditions, is 59 gallons for standard tanks and 78 gallons for optional long range tanks.

In this system, fuel flows from both wing tanks to a selector valve; here, fuel from either or both tanks may be selected, depending upon the cruise requirements. Fuel from the selector valve then flows through a fuel accumulator tank, shutoff valve and associated components as in the "ON-OFF" fuel system. Vapor and excess fuel from the engine-driven fuel pump and fuel control unit are returned through the accumulator tank to the main tanks.

The LEFT TANK position of the three-position selector valve provides fuel flow from the left wing tank to the engine. Similarly, the RIGHT TANK position provides flow from the right wing tank. The BOTH ON position allows fuel flow from both tanks simultaneously.

NOTE

Take-off and land with the selector valve handle in the BOTH ON position to prevent inadvertent operation on an empty tank. However, when the selector is left in the BOTH ON position for extended flight, unequal fuel flow from each tank may occur if the wings are not maintained exactly level. Resulting wing heaviness can be alleviated gradually by turning the selector valve handle to the tank in the "heavy" wing.

The recommended cruise fuel management procedure for extended flight is to use the left and right tank alternately.

NOTE

It is not practical to measure the time required to con-

STATIC DISCHARGERS

If frequent IFR flights are planned, installation of optional static dischargers is recommended to improve radio communications during flight through dust or various forms of precipitation (rain, freezing rain, snow or ice crystals). Under these conditions, the build-up and discharge of static electricity from the wing tips, trailing edges of the wings, rudder, elevators, propeller tips and radio antennas, can result in loss of usable radio signals on all communications and navigation radio equipment. (Usually the ADF is first to be affected and VHF communication equipment is the last to be affected).

Installation of the static dischargers reduces interference from precipitation static, but it is possible to encounter severe precipitation static conditions which might cause the loss of radio signals, even with the static dischargers installed. Whenever possible, avoid known severe precipitation areas to prevent loss of dependable radio signals. If avoidance is impractical, minimize airspeed and anticipate temporary loss of radio signals while in these areas.

The installation of Cessna radio equipment provides certain audio back-up capabilities and transmitter selector switch functions that the pilot should be familiar with. When the transmitter selector switch is placed in the No. 1 or 2 position, the audio amplifier of the corresponding transceiver is utilized to provide the speaker audio for all radios. If the audio amplifier in the selected transceiver fails, as evidenced by loss of speaker audio for all radios, place the transmitter selector switch in the other transceiver position. Since an audio amplifier is not utilized for headphones, a malfunctioning amplifier will not affect headphone operation.

SPEAKER-PHONE SWITCHES.

The speaker-phone switches determine whether the output of the receiver in use is fed to the headphones or through the audio amplifier to the speaker. Place the switch for the desired receiving system either in the up position for speaker operation or in the down position for headphones. On some aircraft, the marker beacon switch contains a third position used to turn off the marker beacon receiver (see figure 7-2).

MICROPHONE - HEADSET

A microphone-headset combination is offered as optional equipment. Using the microphone-headset and a microphone keying switch on the left side of the pilot's control wheel, the pilot can conduct radio communications without interrupting other control-operations to handle a hand-held microphone. Also, passengers need not listen to all communications. The microphone and headset jacks are located near the lower left corner of the instrument panel.

sume all of the fuel in one tank, and, after switching to the opposite tank, expect an equal duration from the remaining fuel. The airspace in both fuel tanks is interconnected by a vent line and, therefore, some sloshing of fuel between tanks can be expected when the tanks are nearly full and the wings are not level.

If it is desired to completely exhaust a fuel tank quantity in flight, the auxiliary fuel pump will be needed to assist in restarting the engine when fuel exhaustion occurs. Therefore, it is recommended that proper operation of the auxiliary fuel pump be verified prior to running a fuel tank dry by turning the auxiliary fuel pump on momentarily and checking for a slight rise in fuel flow indication.

To ensure a prompt engine restart in flight after running a fuel tank dry, immediately switch to a tank containing fuel at the first indication of fuel pressure fluctuation and/or power loss. Then place the right half of the auxiliary fuel pump switch in the ON position momentarily (3 to 5 seconds) with the throttle at least 1/2 open. Excessive use of the auxiliary fuel pump at high altitude and full rich mixture can cause flooding of the engine as indicated by a short (1 to 2 seconds) period of power followed by a loss of power. This can later be detected by a fuel flow indication accompanied by a lack of power. If flooding does occur, turn off the auxiliary fuel pump switch, and normal propeller windmilling should start the engine in 1 to 2 seconds.

If the propeller should stop (possible at very low airspeeds) before the tank containing fuel is selected, place the auxiliary fuel pump switch in the ON position and advance the throttle promptly until the fuel flow indicator registers approximately 1/2 way into the green arc for 1 to 2 seconds duration. Then retard the throttle, turn off the auxiliary fuel pump, and use the starter to turn the engine over until a start is obtained.

FUEL TANK SUMP AND FUEL LINE QUICK-DRAIN VALVES.

Each fuel tank sump is equipped with a fuel quick-drain valve to facilitate draining and/or examination of fuel for contamination and grade. The valve extends through the lower surface of the wing just outboard of the cabin door. Two similar valves are provided in the fuel supply lines and are located on the bottom of the fuselage below the cabin door area. A sampler cup stored in the aircraft is used to examine the fuel. Insert the probe in the sampler cup into the center of the quick-drain valve and push. Fuel will drain into the sampler cup until pressure on the valve is released.

LONG RANGE FUEL TANKS (OPT).

Special wings with long range fuel tanks are available to replace the standard wings and fuel tanks for greater endurance and range. When these tanks are installed, the aircraft is equipped with a "selector valve" fuel system. The total usable fuel, for all flight conditions, is 78 gallons.

AUXILIARY FUEL PUMP SWITCH.

The auxiliary fuel pump switch is located on the left side of the lower switch and control panel and is a yellow and red split-rocker type switch.

The yellow right half of the switch is labeled START, and its upper ON position is used for normal starting, minor vapor purging and continued engine operation in the event of an engine-driven fuel pump failure. With the right half of the switch in the ON position, the pump operates at one of two flow rates that are dependent upon the setting of the throttle. With the throttle open to a cruise setting, the pump operates at a high enough capacity to supply sufficient fuel flow to maintain flight with an inoperative engine-driven fuel pump. When the throttle is moved toward the closed position (as during letdown, landing, and taxiing), the fuel pump flow rate is automatically reduced, preventing an excessively rich mixture during these periods of reduced engine speed.

NOTE

If the engine-driven fuel pump is functioning and the auxiliary fuel pump switch is placed in the ON position, a fuel/air ratio considerably richer than best power is produced unless the mixture is leaned. Therefore, this switch should be turned off during take-off.

NOTE

If the auxiliary fuel pump switch is accidentally placed in the ON position with the master switch on and the engine stopped, the intake manifolds will be flooded.

The red left half of the switch is labeled EMERG, and its upper HI position is used in the event of an engine-driven fuel pump failure during take-off or high power operation. The HI position may also be used for extreme vapor purging. Maximum fuel flow is produced when the left half of the switch is held in the spring-loaded HI position. In this position, an interlock within the switch automatically trips the right half of the switch to the ON position. When the spring-loaded left half of the switch is released, the right half will remain in the ON position until manually returned to the off position.

RADIO SELECTOR SWITCHES

RADIO SELECTOR SWITCH OPERATION.

Operation of the radio equipment is normal as covered in the respective radio manuals. When more than one radio is installed, an audio switching system is necessary. The operation of this switching system is described below. Figure 7-2 illustrates the radio selector switch panel.

TRANSMITTER SELECTOR SWITCH.

The transmitter selector switch has two positions. When two transmitters are installed, it is necessary to switch the microphone to the radio unit the pilot desires to use for transmission. This is accomplished by placing the transmitter selector switch in the position corresponding to the radio unit which is to be used. The up position selects the upper transmitter and the down position selects the lower transmitter.

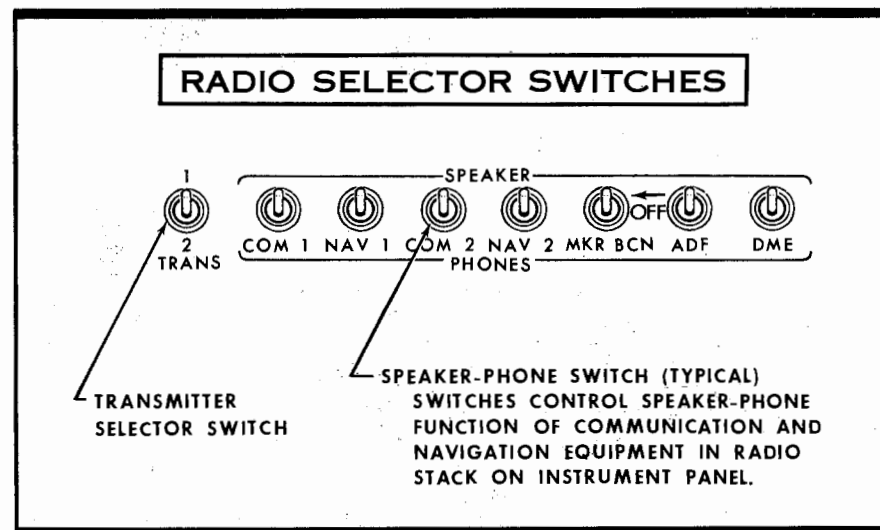

Figure 7-2.

For quick smooth engine starts in zero degree temperatures, use six strokes of the primer before cranking, with an additional one or two strokes as the engine starts. In colder temperatures, use additional priming before cranking, and turn the auxiliary fuel pump switch to ON while cranking.

STATIC PRESSURE ALTERNATE SOURCE VALVE.

A static pressure alternate source valve provides continued operation of the airspeed indicator, altimeter, and vertical speed indicator in the event that the static ports or lines become obstructed. The valve is a push off-pull on type valve located under the left switch and control panel.

If erroneous instrument readings are suspected due to water or ice in the static pressure lines, the alternate static source valve should be opened to close off the standard static system and vent the instruments to cabin static pressure. Cabin pressures will vary, however, with open vents or windows. Since open cabin windows will cause large errors in altimeter and airspeed readings at cruise speeds, it is recommended that they be closed whenever the alternate static system is in use.

If the windows are closed, the airspeed indicator and altimeter may read as much as 6 MPH slower and 50 feet lower, respectively, depending on airspeed and the position of the cabin ventilators. If the alternate static source must be used for landing, use an indicated airspeed 4 MPH slower than normal.

ELECTRICAL SYSTEM.

Electrical energy is supplied by a 14-volt, direct-current system powered by an engine-driven alternator (see figure 2-4). The 12-volt battery is located aft of the rear cabin wall below the baggage floor. Power is supplied to all electrical circuits through a split bus bar, one side containing electronic system circuits and the other side having general electrical system circuits. Both sides of the bus are on at all times except when either an external power source is connected or the starter switch is turned on; then a power contactor is automatically activated to open the circuit to the electronics bus. Isolating the electronic circuits in this manner prevents harmful transient voltages from damaging the transistors in the electronics equipment.

MASTER SWITCH.

The master switch is a split-rocker type switch labeled MASTER, and is ON in the up position and off in the down position. The right half of the switch, labeled BAT, controls all electrical power to the aircraft. The left half, labeled ALT, controls the alternator.

Normally, both sides of the master switch should be used simultaneously; however, the BAT side of the switch could be turned ON separately to check equipment while on the ground. The ALT side of the switch, when placed in the off position, removes the alternator from the electrical system. With this switch in the off position, the entire electrical load is placed on the battery. Continued operation with the alternator switch off will reduce battery power low enough to open the battery contactor, remove power from the alternator field, and prevent alternator restart.

AMMETER.

The ammeter indicates the flow of current, in amperes, from the alternator to the battery or from the battery to the aircraft electrical system. When the engine is operating and the master switch is ON, the ammeter indicates the charging rate applied to the battery. In the event the alternator is not functioning or the electrical load exceeds the output of the alternator, the ammeter indicates the discharge rate of the battery.

OVER-VOLTAGE SENSOR AND WARNING LIGHT.

The aircraft is equipped with an automatic over-voltage protection

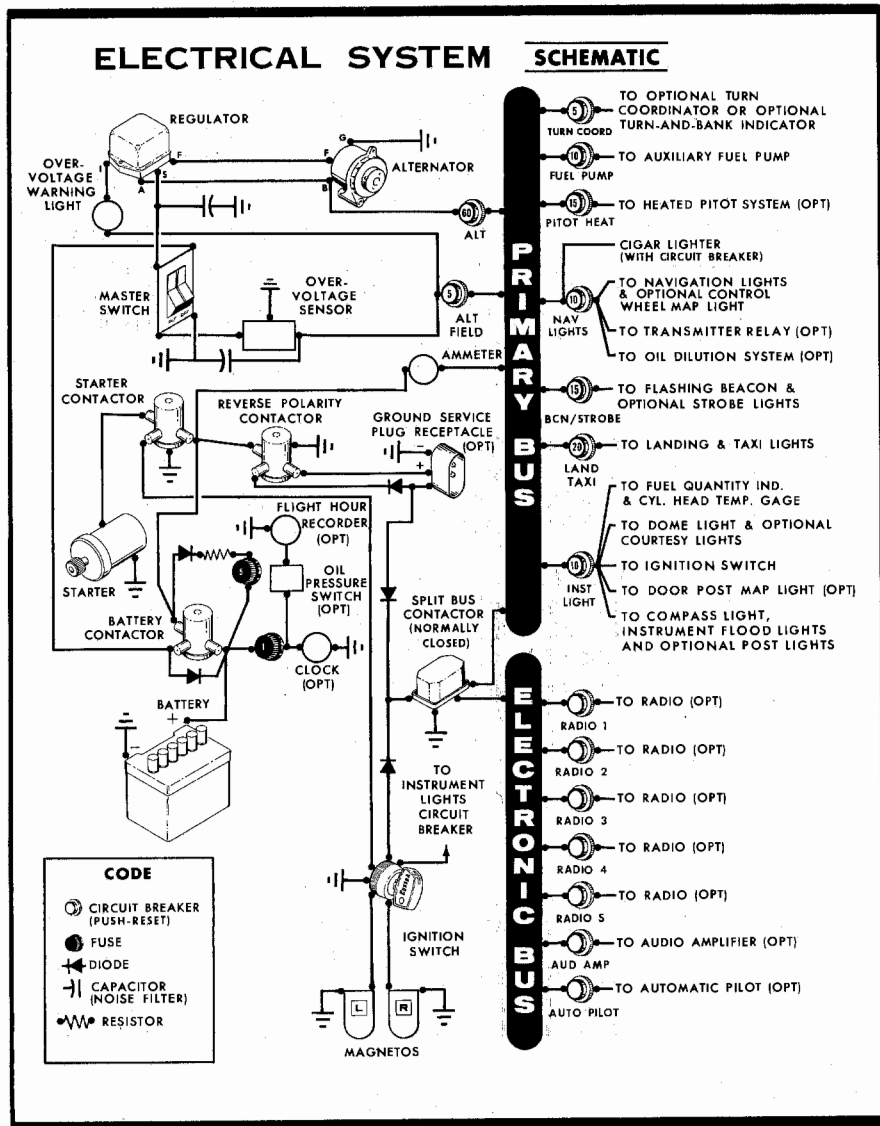

Figure 2-4.

OIL DILUTION TABLE		TEMPERATURE		
		0°F	-10°F	-20°F
DILUTION TIME	2 min.	5 min.	8 min.	
FUEL ADDED	1 qt.	2.5 qt.	4 qt.	

Maximum Sump Capacity - 16 quarts
 Maximum for Take-off - 13 quarts

Figure 7-1.

energizing the oil dilution switch with the engine operating at 1000 RPM, and with the auxiliary fuel pump switch in the ON position. (Refer to figure 7-1 for dilution time for the anticipated temperature.) While diluting the oil, the oil pressure should be watched for any unusual fluctuations that might indicate a screen being clogged with sludge washed down by the fuel.

NOTE

On the first operation of the oil dilution system each season, use the full dilution period, drain the oil, clean the screen, refill with new oil and redilute as required.

If the full dilution time was used, beginning with a full oil sump (12 quarts), subsequent starts and engine warm-up should be prolonged to evaporate enough of the fuel to lower the oil sump level to 13 quarts prior to take-off. Otherwise, the sump may overflow when the aircraft is in a nose high attitude.

To avoid progressive dilution of the oil, flights of at least two hours' duration should be made between oil dilution operations.

ENGINE PRIMER SYSTEM.

A manually-operated, plunger-type engine primer may be installed to improve cold weather starting.

GROUND SERVICE PLUG RECEPTACLE.

A ground service plug receptacle may be installed to permit the use of an external power source for cold weather starting and during lengthy maintenance work on the aircraft electrical system (with the exception of electronic equipment).

NOTE

Electrical power for the aircraft electrical circuits is provided through a split bus bar having all electronic circuits on one side of the bus and other electrical circuits on the other side of the bus. When an external power source is connected, a contactor automatically opens the circuit to the electronic portion of the split bus bar as a protection against damage to the transistors in the electronic equipment by transient voltages from the power source. Therefore, the external power source can not be used as a source of power when checking electronic components.

Just before connecting an external power source (generator type or battery cart), the master switch should be turned ON.

The ground service plug receptacle circuit incorporates a polarity reversal protection. Power from the external power source will flow only if the ground service plug is correctly connected to the airplane. If the plug is accidentally connected backwards, no power will flow to the airplane's electrical system, thereby preventing any damage to electrical equipment.

The battery and external power circuits have been designed to completely eliminate the need to "jumper" across the battery contactor to close it for charging a completely "dead" battery. A special fused circuit in the external power system supplies the needed "jumper" across the contacts so that with a "dead" battery and an external power source applied, turning the master switch ON will close the battery contactor.

OIL DILUTION SYSTEM.

If your aircraft is equipped with an oil dilution system, and very low temperatures are anticipated, dilute the oil prior to engine shut down by

system consisting of an over-voltage sensor behind the instrument panel and a red warning light, labeled HIGH VOLTAGE, near the ammeter.

In the event an over-voltage condition occurs, the over-voltage sensor automatically removes alternator field current and shuts down the alternator. The red warning light will then turn on, indicating to the pilot that the alternator is not operating and the aircraft battery is supplying all electrical power.

The over-voltage sensor may be reset by turning the master switch off and back on again. If the warning light does not illuminate, normal alternator charging has resumed; however, if the light does illuminate again, a malfunction has occurred, and the flight should be terminated as soon as practical.

The over-voltage warning light may be tested by momentarily turning off the ALT portion of the master switch and leaving the BAT portion turned on.

CIRCUIT BREAKERS AND FUSES.

Most of the electrical circuits in the airplane are protected by "push-to-reset" circuit breakers mounted on the instrument panel. Exceptions to this are the battery contactor closing (external power) circuit and optional clock and flight hour recorder circuits which have fuses mounted near the battery. Also, the cigar lighter is protected by a manually-reset type circuit breaker mounted directly on the back of the lighter behind the instrument panel.

When more than one radio is installed, the radio transmitter relay (which is a part of the radio installation) is protected by the navigation lights circuit breaker labeled NAV LIGHTS. It is important to remember that any malfunction in the navigation lights system which causes the circuit breaker to open will de-activate both the navigation lights and the transmitter relay. In this event, the navigation light switch should be turned off to isolate the circuit; then reset the circuit breaker to reactivate the transmitter relay and permit its usage. Do not turn on the navigation lights switch until the malfunction has been corrected.

LIGHTING EQUIPMENT.

EXTERIOR LIGHTING.

Standard exterior lighting consists of navigation lights on the wing tips

OPTIONAL SYSTEMS

and tailcone stinger, landing and taxi lights mounted in the cowl nose cap, and a flashing beacon on top of the vertical fin. Optional lighting includes a strobe light on each wing tip, and a courtesy light under each wing just outboard of the cabin. The courtesy lights are controlled by the dome light switch, labeled DOME/COURTESY, located on the overhead console. All exterior lights, except the courtesy lights, are controlled by rocker-type switches on the left switch and control panel. The switches are ON in the up position and off in the down position.

The flashing beacon should not be used when flying through clouds or overcast; the flashing light reflected from water droplets or particles in the atmosphere, particularly at night, can produce vertigo and loss of orientation.

The two high intensity strobe lights will enhance anti-collision protection. However, the lights should be turned off when taxiing in the vicinity of other aircraft, or during night flight through clouds, fog or haze.

INTERIOR LIGHTING.

Instrument and control panel lighting is provided by standard flood lighting, optional post lighting, and integral lighting. Two rheostat control knobs, labeled RADIO and INSTRUMENT, control the intensity of all instrument and control panel lighting. The rheostat control knobs are located on the left and right sides of the overhead console. A switch on the overhead console, labeled POST-FLOOD is used to select either standard flood lighting or optional post lighting.

Standard instrument panel lighting consists of a flood light equipped with a red lens in the overhead console, a white post light adjacent to the radio selector switches, two red post lights (one above the switch panel and one above the control panel), and a red post light mounted under the edge of the instrument panel near the center to illuminate the floor console controls. The magnetic compass and engine instrument cluster have integral red lighting, and the radios have integral white lighting. To use flood lighting, place the switch labeled POST-FLOOD in the FLOOD position and adjust the light intensity. Intensity of the overhead flood light, compass light, instrument cluster lights, and the switch and control panel and floor console post lights is controlled by the INSTRUMENT rheostat control knob. The intensity of the integral radio lights and the radio selector switch panel post light is controlled by the RADIO rheostat control knob.

The instrument panel may be equipped with optional white post lights mounted at the edge of each instrument and the edge of the marker beacon

This section contains a description, operating procedures, and performance data (when applicable) for some of the optional equipment which may be installed in your Cessna. Owner's Manual Supplements are provided to cover operation of other optional equipment systems when installed in your aircraft. Contact your Cessna Dealer for a complete list of available optional equipment.

COLD WEATHER EQUIPMENT

WINTERIZATION KIT AND NON-CONGEALING OIL COOLER.

For continuous operation in temperatures consistently below 20°F, the Cessna winterization kit and non-congealing oil cooler should be installed to improve engine operation. The winterization kit consists of two shields to partially cover the cowl nose cap openings, a cover plate with a hole in it to cover the induction air filter, and insulation for the crankcase breather line.

NOTE

The cover plate should be installed on the front of the air filter rather than between the filter and the airbox.

Once installed, the crankcase breather insulation is approved for permanent use in both cold and hot weather. The non-congealing oil cooler replaces the standard oil cooler and provides improved oil flow through the cooler in extremely cold weather.

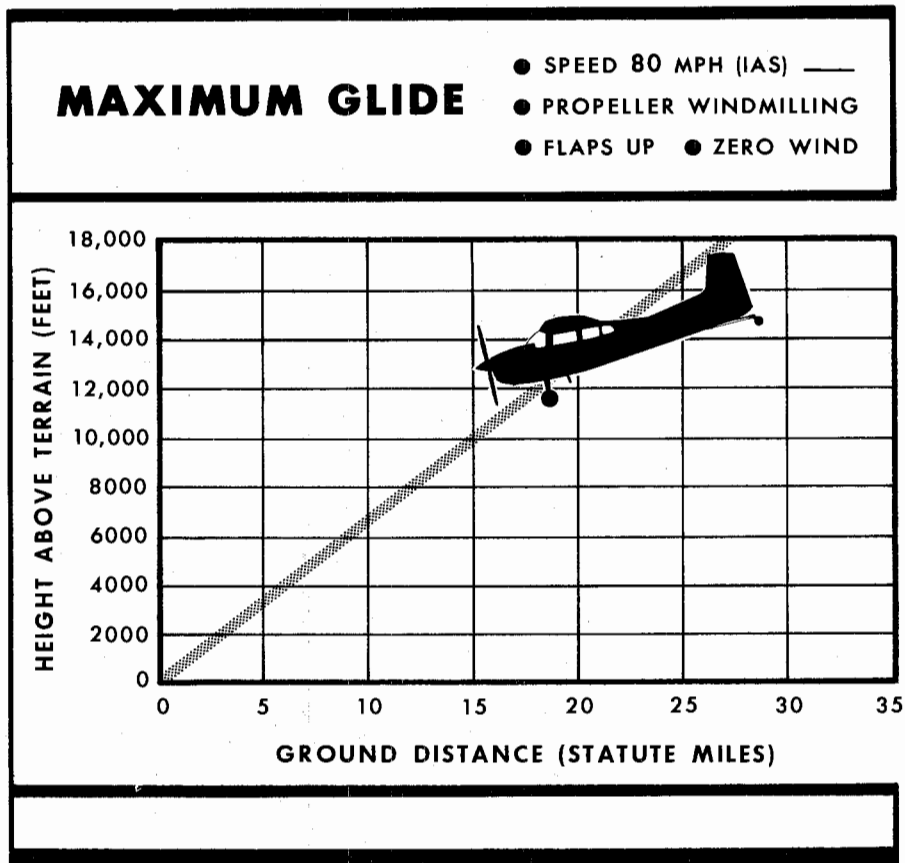

Figure 6-6.

panel to provide direct lighting. When post lights are installed, the red lights of the engine instrument cluster are replaced with white lights and the cluster lighting is connected to the post light switch. Therefore, when flood lighting is used, the engine instrument cluster will not have integral lighting. To utilize post lighting, place the switch labeled POST-FLOOD in the POST position. In this position, the overhead flood light will turn off automatically. Post light intensity is adjusted with the INSTRUMENT rheostat control knob.

A cabin dome light is located in the overhead console, and is operated by a switch adjacent to the light. To turn the light on, move the switch to the left. This will also operate the optional courtesy lights.

An optional map light may be mounted on the bottom of the pilot's control wheel. The light illuminates the lower portion of the cabin, just forward of the pilot, and is helpful when checking maps and other flight data during night operations. To operate the light, first turn on the NAV LIGHTS switch, then adjust the map light's intensity with the rheostat control knob on the back of the control wheel pad on the right side.

A doorpost map light is also offered as optional equipment, and is located on the left forward doorpost. The light contains both red and white bulbs, and may be positioned to illuminate any area desired by the pilot. A switch on the left forward doorpost is labeled RED, OFF, and WHITE. Placing the switch in the top position will provide a red light. In the bottom position, standard white lighting is provided. The center position is OFF.

CABIN HEATING, VENTILATING AND DEFROSTING SYSTEM.

The temperature and volume of airflow into the cabin can be regulated to any degree desired by manipulation of the push-pull CABIN HEAT and CABIN AIR knobs.

NOTE

For improved partial heating on mild days, pull out the CABIN AIR knob slightly when the CABIN HEAT knob is out. This action increases the airflow through the system, increasing efficiency, and blends cool outside air with the exhaust manifold heated air, thus eliminating the possibility of overheating the system ducting.

Front cabin heat and ventilating air is supplied by outlet holes spaced across a cabin manifold just forward of the pilot's and copilot's feet. Rear cabin heat and air is supplied by two ducts from the manifold, one extending down each side of the cabin to an outlet at the front door post at floor level. Windshield defrost air is also supplied by a duct leading from the cabin manifold.

Separate adjustable ventilators supply additional air; one near each upper corner of the windshield supplies air for the pilot and copilot, and two in the rear cabin ceiling supply air to the rear seat passengers.

SHOULDER HARNESSSES.

Shoulder harnesses are standard equipment for the pilot and optional equipment for the passengers.

Each front seat harness is attached to a rear door post just above window line and is stowed behind a stowage sheath mounted above the cabin door. To stow each front seat harness, fold the free end and place it behind the sheath. The center seat shoulder harnesses are attached near the aft windows. Each harness is stowed by fastening the loose end to the adhesive type fastener near the harness attach point. The aft seat shoulder harnesses are attached to the rear cabin bulkhead. They are stowed behind clips below the aft cabin window.

To use the shoulder harnesses, fasten and adjust the seat belt first. Remove the harness from the stowed position, and lengthen as required by pulling on the end of the harness and the narrow release strap. Snap the harness metal stud firmly into the retaining slot adjacent to the seat belt buckle. Then adjust to length by pulling down on the free end of the harness. A properly adjusted harness will permit the occupant to lean forward enough to sit completely erect, but is tight enough to prevent excessive forward movement and contact with objects during sudden deceleration. Also, there should be enough slack in the pilot's shoulder harness to permit use of the wing flap handle.

Releasing and removing the shoulder harness is accomplished by pulling upward on the narrow release strap, and removing the harness stud from the slot in the seat belt buckle. In an emergency, the shoulder harness may be removed by releasing the seat belt first, and then pulling the harness over the head by pulling up on the release strap.

LANDING DISTANCE TABLE									
LANDING DISTANCE WITH 40° FLAPS ON HARD SURFACE RUNWAY									
GROSS WEIGHT POUNDS	APPROACH IAS MPH	@ SEA LEVEL & 59°F		@ 2500 FEET & 50°F		@ 5000 FEET & 41°F		@ 7500 FEET & 32°F	
		GROUND ROLL	TOTAL TO CLEAR 50 FT OBS	GROUND ROLL	TOTAL TO CLEAR 50 FT OBS	GROUND ROLL	TOTAL TO CLEAR 50 FT OBS	GROUND ROLL	TOTAL TO CLEAR 50 FT OBS
3350	78	480	1400	510	1485	540	1580	575	1680

NOTES: 1. Distances shown are based on zero wind, power off, and heavy braking.
 2. Reduce landing distances 10% for each 5 knots headwind.
 3. Minimum total landing distances are obtainable in smooth air with a 70 MPH approach speed. The above total distances can be reduced approximately 10% using the slower approach speed.
 4. For operation on a dry, grass runway, increase distances (both "ground roll" and "total to clear 50 ft. obstacle") by 20% of the "total to clear 50 ft. obstacle" figure.

Figure 6-5.

CRUISE PERFORMANCE											
EXTENDED RANGE MIXTURE											
Standard Conditions — Zero Wind — Gross Weight-3350 Pounds											
15,000 FEET											
RPM	MP	% BHP	TAS MPH	GAL/HOUR	"ON-OFF" FUEL SYS.		"SELECTOR VALVE" FUEL SYS.				
					62 GALLONS (NO RESERVE)		59 GALLONS (NO RESERVE)		78 GALLONS (NO RESERVE)		
					ENDR. HOURS	RANGE MILES	ENDR. HOURS	RANGE MILES	ENDR. HOURS	RANGE MILES	
2550	17	57	157	12.1	5.1	805	4.9	765	6.4	1010	
	16	53	149	11.2	5.5	820	5.3	785	6.9	1035	
	15	48	139	10.4	6.0	835	5.7	790	7.5	1050	
	14	43	124	9.5	6.6	810	6.2	775	8.3	1020	
2500	17	55	154	11.7	5.3	810	5.0	775	6.6	1020	
	16	51	146	10.9	5.7	825	5.4	785	7.2	1040	
	15	46	135	10.1	6.2	830	5.9	790	7.8	1045	
	14	42	117	9.2	6.7	795	6.4	755	8.5	1000	
2400	17	52	148	11.1	5.6	825	5.3	785	7.0	1035	
	16	48	138	10.3	6.0	830	5.7	790	7.6	1045	
	15	43	125	9.5	6.5	815	6.2	775	8.2	1025	
	14	39	105	8.6	7.2	750	6.8	715	9.0	945	
2300	17	48	140	10.4	5.9	835	5.7	795	7.5	1050	
	16	44	129	9.7	6.4	830	6.1	790	8.1	1040	
	15	40	111	8.9	6.9	775	6.6	735	8.7	975	
	14	36	93	8.2	7.6	710	7.2	675	9.6	890	
2200	17	45	131	9.8	6.3	830	6.0	790	8.0	1045	
	16	41	115	9.1	6.8	785	6.5	750	8.6	990	
	15	37	99	8.4	7.4	730	7.0	695	9.3	915	
	14	33	81	7.7	8.1	660	7.7	630	10.2	830	

NOTE: For cargo pack performance, refer to Section VII.

Figure 6-4 (Sheet 5 of 5).

INTEGRATED SEAT BELT/SHOULDER HARNESSSES WITH INERTIA REELS.

Optional integrated seat belt/shoulder harnesses with inertia reels are available for the pilot and front seat passenger. The seat belt/shoulder harnesses extend from inertia reels in the cabin ceiling to attach points inboard of the two front seats. A separate seat belt half and buckle is located outboard of the seats. The inertia reels are located in the aft overhead console, and are labeled PILOT and COPILOT. Inertia reels allow complete freedom of body movement. However, in the event of a sudden deceleration, they will lock up automatically to protect the occupants.

To use the seat belt/shoulder harness, adjust the metal buckle half on the harness up far enough to allow it to be drawn across the lap of the occupant and be fastened into the outboard seat belt buckle. Adjust seat belt tension by pulling up on the shoulder harness. To remove the seat belt/shoulder harness, release the seat belt buckle and allow the inertia reel to draw the harness to the inboard side of the seat.

REMOVABLE CABIN DOOR.

The right cabin door has removable hinge pins and a detachable door stop permitting door removal when large or bulky cargo must be loaded.

AFT BAGGAGE COMPARTMENT.

A baggage compartment (baggage area 2) is provided just back of the rear cabin wall and is accessible by taking off the quick-removable wall panel. The compartment is useful for storing utility type seating when large cargo is to be carried in the cabin area. Also, it provides an extra storage space for light, but bulky articles. A total of 50 pounds of baggage may be carried in this area. Four tie-down rings and a baggage net are used to tie down the baggage. Weight and balance data and illustrations of the compartment may be found in Section IV.

MANUAL TAIL WHEEL LOCK.

The steerable tail wheel incorporates a manual anti-swivel locking system. The locking lever, located on the cabin floor console, controls a spring-loaded locking lug on the tail wheel assembly. To lock the tail wheel, move the lever aft to the LOCK position. To unlock the tail

wheel, move the lever forward to UNLOCK.

STARTING ENGINE.

Proper fuel management and throttle adjustments are the determining factors in securing an easy start from your continuous-flow fuel-injection engine. The procedure outlined in Section I should be followed closely as it is effective under nearly all operating conditions, including hot and cold weather conditions. Slight variations from this procedure may be necessary at times to compensate for extreme conditions.

Conventional full rich mixture and high RPM propeller settings are used for starting; the throttle, however, should be fully closed initially. When ready to start, place the auxiliary fuel pump switch in the ON position and advance the throttle to obtain 8-10 gal/hr fuel flow. Then, promptly turn off the auxiliary fuel pump and return the throttle to idle. Place the ignition switch in the START position. While cranking, slowly advance the throttle until the engine starts. Slow throttle advancement is essential since the engine will start readily when the correct fuel/air ratio is obtained. When the engine has started, reset the throttle to the desired idle speed.

Engine starting in hot weather or with a hot engine is sometimes hampered by vapor formation in the fuel lines. To purge the vapor, move the mixture control to full rich, open the throttle 1 1/2 inches, and prime with the auxiliary fuel pump switch in the ON position (or HI position, as required) until the fuel flow indicator reads 8-10 gal/hr. Then shut off the fuel pump switch and engage the starter. As the flooded mixture becomes progressively leaner, reaching a combustible mixture, the engine will start. If the engine tends to die, turn the auxiliary fuel pump switch momentarily to ON at appropriate intervals until the vapor is fully cleared and the engine runs smoothly.

If prolonged cranking is necessary, allow the starter motor to cool at frequent intervals, since excessive heat may damage the armature.

TAXIING.

The tail wheel lock should be unlocked for steering while taxiing.

Taxiing over loose gravel or cinders should be done at low engine speed to avoid abrasion and stone damage to the propeller tips.

CRUISE PERFORMANCE										
EXTENDED RANGE MIXTURE										
Standard Conditions \searrow Zero Wind \swarrow Gross Weight-3350 Pounds										
10,000 FEET										
RPM	MP	% BHP	TAS MPH	GAL/HOUR	"ON-OFF" FUEL SYS.		"SELECTOR VALVE" FUEL SYS.			
					62 GALLONS (NO RESERVE)		59 GALLONS (NO RESERVE)		78 GALLONS (NO RESERVE)	
					ENDR. HOURS	RANGE MILES	ENDR. HOURS	RANGE MILES	ENDR. HOURS	RANGE MILES
2550	21	70	166	14.6	4.3	705	4.0	670	5.4	890
	20	65	161	13.7	4.5	730	4.3	695	5.7	915
	19	61	156	12.9	4.8	755	4.6	720	6.1	950
	18	57	151	12.0	5.2	775	4.9	740	6.5	980
2500	21	67	163	14.1	4.4	715	4.2	680	5.5	900
	20	63	159	13.3	4.7	740	4.4	705	5.9	930
	19	59	154	12.5	5.0	765	4.7	730	6.3	960
	18	55	148	11.7	5.3	785	5.1	750	6.7	990
2400	21	63	158	13.2	4.7	745	4.5	705	5.9	935
	20	59	154	12.5	5.0	765	4.7	725	6.2	960
	19	55	149	11.7	5.3	785	5.0	745	6.6	985
	18	51	142	11.0	5.6	800	5.4	765	7.1	1010
2300	21	59	154	12.4	5.0	765	4.7	730	6.3	965
	20	55	149	11.8	5.3	785	5.0	745	6.6	985
	19	52	143	11.1	5.6	800	5.3	760	7.1	1005
	18	48	136	10.4	6.0	815	5.7	775	7.5	1025
2200	21	55	148	11.6	5.3	790	5.1	750	6.7	990
	20	51	142	11.0	5.6	800	5.4	765	7.1	1010
	19	48	136	10.4	6.0	815	5.7	775	7.5	1025
	18	44	129	9.7	6.4	825	6.1	785	8.0	1035
	17	41	119	9.0	6.9	820	6.5	780	8.6	1030

NOTE: For cargo pack performance, refer to Section VII.

Figure 6-4 (Sheet 4 of 5).

CRUISE PERFORMANCE

EXTENDED RANGE MIXTURE

Standard Conditions \searrow Zero Wind \swarrow Gross Weight-3350 Pounds

7500 FEET

RPM	MP	% BHP	TAS MPH	GAL/HOUR	"ON-OFF" FUEL SYS.		"SELECTOR VALVE" FUEL SYS.			
					62 GALLONS (NO RESERVE)		59 GALLONS (NO RESERVE)		78 GALLONS (NO RESERVE)	
					ENDR. HOURS	RANGE MILES	ENDR. HOURS	RANGE MILES	ENDR. HOURS	RANGE MILES
2550	23	75	168	15.8	3.9	660	3.7	625	4.9	830
	22	71	164	14.9	4.2	680	4.0	645	5.2	855
	21	67	160	14.1	4.4	705	4.2	670	5.5	885
	20	63	155	13.2	4.7	725	4.5	690	5.9	915
2500	23	73	165	15.3	4.1	670	3.9	640	5.1	845
	22	69	162	14.5	4.3	690	4.1	660	5.4	870
	21	65	157	13.7	4.5	715	4.3	680	5.7	900
	20	61	153	12.8	4.8	740	4.6	705	6.1	930
2400	23	68	161	14.3	4.3	700	4.1	665	5.5	880
	22	64	157	13.5	4.6	720	4.4	685	5.8	905
	21	61	153	12.8	4.9	740	4.6	705	6.1	930
	20	57	148	12.1	5.1	760	4.9	725	6.5	960
2300	23	64	156	13.4	4.6	720	4.4	685	5.8	905
	22	60	152	12.7	4.9	740	4.6	705	6.1	935
	21	57	148	12.0	5.2	760	4.9	725	6.5	960
	20	53	143	11.4	5.5	780	5.2	745	6.9	980
2200	23	59	151	12.5	5.0	750	4.7	715	6.3	945
	22	56	147	11.9	5.2	765	5.0	730	6.6	965
	21	53	142	11.2	5.5	785	5.2	745	6.9	985
	20	49	137	10.6	5.8	800	5.6	760	7.3	1005
	19	46	131	10.0	6.2	810	5.9	775	7.8	1020
	18	42	123	9.3	6.6	820	6.3	780	8.4	1030

NOTE: For cargo pack performance, refer to Section VII.

BEFORE TAKE-OFF.

WARM-UP.

Since the engine is closely cowl for efficient in-flight cooling, precautions should be taken to avoid overheating on the ground. Full throttle checks on the ground are not recommended unless the pilot has good reason to suspect that the engine is not turning up properly.

MAGNETO CHECK.

The magneto check should be made at 1700 RPM with the propeller in flat pitch as follows: Move the ignition switch first to R position and note RPM. Next move switch back to BOTH position to clear the other set of plugs. Then move switch to L position, note RPM and return the switch to the BOTH position. RPM drop should not exceed 150 RPM on either magneto or show greater than 50 RPM differential between magnetos. If there is a doubt concerning operation of the ignition system, RPM checks at higher engine speeds will usually confirm whether a deficiency exists.

An absence of RPM drop may be an indication of faulty grounding of one side of the ignition system or should be cause for suspicion that the magneto timing is set in advance of the setting specified.

ALTERNATOR CHECK.

Prior to flights where verification of proper alternator and voltage regulator operation is essential (such as night or instrument flights), a positive verification can be made by loading the electrical system momentarily (3 to 5 seconds) with the landing and taxi lights during the engine runup (1700 RPM). The ammeter will remain within a needle width of zero if the alternator and voltage regulator are operating properly.

TAIL WHEEL LOCK.

Take-offs may be conducted with the tail wheel lock engaged or disengaged. Tail wheel steering of 24°, left and right, is available with the tail wheel lock disengaged. Engaging the lock limits the steering to 2.5° left and right.

Take-offs will normally be conducted with the lock disengaged to get maximum steering in the early part of the take-off run. Speeds are usually low enough in this regime to preclude tail wheel shimmy under even the most unfavorable combination of rough field conditions and high gross weight.

Figure 6-4 (Sheet 3 of 5).

TAKE-OFF.

It is important to check full-throttle engine operation early in the take-off run. Any signs of rough engine operation or sluggish engine acceleration is good cause for discontinuing the take-off.

Full throttle runups over loose gravel are especially harmful to the propeller tips and stabilizer leading edge. When take-offs must be made over a gravel surface, it is very important that the throttle be advanced slowly. This allows the airplane to start rolling before high RPM is developed, and the gravel will be blown back of the propeller rather than pulled into it.

After full throttle is applied, adjust the throttle friction lock clockwise to prevent the throttle from creeping back from a maximum power position. Similar friction lock adjustments should be made as required in other flight conditions to maintain a fixed throttle setting.

For maximum engine power, the mixture should be adjusted during the initial take-off roll to the fuel flow corresponding to the field elevation. The power increase is significant above 3000 feet and this procedure always should be employed for field elevations greater than 5000 feet above sea level.

Using 20° wing flaps reduces the ground run and total distance over an obstacle by approximately 20 per cent. Soft field take-offs are performed with 20° flaps by lifting the aircraft off the ground as soon as practical in a tail-low attitude. However, the aircraft should be leveled off immediately to accelerate to a safe climb speed.

If 20° wing flaps are used for take-off, they should be left down until all obstacles are cleared. To clear an obstacle with wing flaps 20°, a 64 MPH climb speed should be used. If no obstructions are ahead, a best "flaps up" rate-of-climb speed (101 MPH) would be most efficient. Flap deflections of 30° and 40° are not recommended for take-off.

Take-offs into strong crosswinds normally are performed with the minimum flap setting necessary for the field length, to minimize the drift angle immediately after take-off. The airplane is accelerated to a speed slightly higher than normal, then pulled off abruptly to prevent possible settling back to the runway while drifting. When clear of the ground, make a coordinated turn into the wind to correct for drift.

CRUISE PERFORMANCE										
EXTENDED RANGE MIXTURE										
Standard Conditions — Zero Wind — Gross Weight- 3350 Pounds										
5000 FEET										
RPM	MP	% BHP	TAS MPH	GAL/HOUR	"ON-OFF" FUEL SYS.		"SELECTOR VALVE" FUEL SYS.			
					62 GALLONS (NO RESERVE)		59 GALLONS (NO RESERVE)		78 GALLONS (NO RESERVE)	
					ENDR. HOURS	RANGE MILES	ENDR. HOURS	RANGE MILES	ENDR. HOURS	RANGE MILES
2550	25	81	168	17.0	3.7	615	3.5	585	4.6	775
	24	77	165	16.1	3.8	635	3.7	605	4.8	800
	23	73	162	15.2	4.1	655	3.9	625	5.1	825
	22	69	158	14.4	4.3	680	4.1	645	5.4	855
2500	25	79	166	16.5	3.8	625	3.6	595	4.7	790
	24	75	163	15.6	4.0	645	3.8	615	5.0	815
	23	71	159	14.8	4.2	670	4.0	635	5.3	840
	22	67	156	14.0	4.4	690	4.2	655	5.6	870
2400	25	73	162	15.3	4.0	655	3.9	625	5.1	825
	24	70	158	14.6	4.3	675	4.0	640	5.3	845
	23	66	155	13.8	4.5	695	4.3	660	5.6	875
	22	62	151	13.1	4.7	715	4.5	680	6.0	900
2300	25	69	158	14.4	4.3	675	4.1	645	5.4	850
	24	65	155	13.7	4.5	695	4.3	665	5.7	875
	23	62	151	13.0	4.8	720	4.5	685	6.0	905
	22	58	147	12.3	5.0	740	4.8	705	6.3	930
2200	25	64	153	13.4	4.6	710	4.4	675	5.8	890
	24	60	149	12.7	4.9	725	4.6	690	6.1	915
	23	57	146	12.1	5.1	745	4.9	710	6.4	940
	22	54	141	11.5	5.4	765	5.1	725	6.8	960
	21	51	137	10.9	5.7	780	5.4	740	7.2	980
	20	47	131	10.2	6.1	795	5.8	755	7.6	1000
	19	44	125	9.6	6.5	810	6.1	770	8.1	1015
	18	40	117	9.0	6.9	815	6.6	775	8.7	1025

NOTE: For cargo pack performance, refer to Section VII.

Figure 6-4 (Sheet 2 of 5).

CRUISE PERFORMANCE

EXTENDED RANGE MIXTURE

Standard Conditions — Zero Wind — Gross Weight- 3350 Pounds

2500 FEET

RPM	MP	% BHP	TAS MPH	GAL/HOUR	"ON-OFF" FUEL SYS.		"SELECTOR VALVE" FUEL SYS.			
					62 GALLONS (NO RESERVE)		59 GALLONS (NO RESERVE)		78 GALLONS (NO RESERVE)	
					ENDR. HOURS	RANGE MILES	ENDR. HOURS	RANGE MILES	ENDR. HOURS	RANGE MILES
2550	25	79	163	16.5	3.8	610	3.6	580	4.7	770
	24	75	159	15.6	4.0	635	3.8	600	5.0	795
	23	70	156	14.7	4.2	655	4.0	625	5.3	825
	22	66	152	13.9	4.5	675	4.2	645	5.6	850
2500	25	76	161	16.0	3.9	625	3.7	595	4.9	785
	24	72	158	15.1	4.1	645	3.9	615	5.2	810
	23	68	154	14.3	4.3	665	4.1	635	5.4	840
	22	64	150	13.5	4.6	690	4.4	655	5.8	865
2400	25	71	157	14.9	4.2	650	4.0	620	5.2	820
	24	68	153	14.2	4.4	670	4.2	635	5.5	840
	23	64	150	13.4	4.6	690	4.4	655	5.8	870
	22	60	146	12.7	4.9	715	4.7	680	6.2	895
2300	25	67	153	14.1	4.4	675	4.2	640	5.6	845
	24	63	149	13.3	4.7	695	4.4	660	5.9	875
	23	60	145	12.6	4.9	715	4.7	680	6.2	900
	22	56	141	11.9	5.2	735	5.0	700	6.5	925
2200	25	62	148	13.0	4.8	705	4.5	670	6.0	885
	24	59	144	12.4	5.0	720	4.8	685	6.3	910
	23	55	140	11.7	5.3	740	5.0	705	6.6	935
	22	52	136	11.1	5.6	760	5.3	725	7.0	955
	21	49	131	10.5	5.9	775	5.6	740	7.4	975
	20	45	126	9.9	6.3	795	6.0	755	7.9	995
	19	42	120	9.2	6.7	805	6.4	765	8.5	1015
	18	38	112	8.6	7.2	805	6.9	770	9.1	1015

NOTE: For cargo pack performance, refer to Section VII.

Figure 6-4 (Sheet 1 of 5).

ENROUTE CLIMB.

A cruising climb at 25 inches and 2550 RPM and 110 to 120 MPH is recommended to save time and fuel for the overall trip. In addition, this type of climb provides better engine cooling, less engine wear, and more passenger comfort due to lower noise level.

Cruising climbs should be conducted at approximately 18 GPH up to 5000 feet and at 1 GPH more than the fuel flow shown on the Cessna Power Computer at higher altitudes and lower power.

If it is necessary to climb rapidly to clear mountains or reach favorable winds at high altitudes, the best rate-of-climb speed should be used with maximum continuous power. This speed is 101 MPH at sea level, decreasing 1/2 MPH for each 1000 feet above sea level. The mixture should be leaned as shown by the 2700 RPM column on the fuel flow placard located on the instrument panel.

If an obstruction ahead requires a steep climb angle, a best angle of climb speed should be used with flaps up and maximum power. This speed is 86 MPH at sea level, increasing to 88 MPH at 10,000 feet above sea level.

CRUISE.

Normal cruising is performed between 55% and 75% power. The corresponding power settings and fuel consumption for various altitudes can be determined by using your Cessna Power Computer or the Operational Data in Section VI.

NOTE

Cruising should be done at 65% to 75% power until a total of 50 hours has accumulated or oil consumption has stabilized. This is to ensure proper seating of the rings and is applicable to new engines, and engines in service following cylinder replacement or top overhaul of one or more cylinders.

The Cruise Performance table on the following page illustrates the true airspeed and miles per gallon during cruise for various altitudes and percent powers. This table should be used as a guide, along with the

CRUISE PERFORMANCE						
ALTITUDE	75% POWER		65% POWER		55% POWER	
	TAS	MPG	TAS	MPG	TAS	MPG
Sea Level	156	9.9	147	10.8	137	11.7
4000 Feet	162	10.3	152	11.2	142	12.1
7500 Feet	168	10.7	157	11.5	146	12.5
Standard Conditions				Zero Wind		

available winds aloft information, to determine the most favorable altitude and power setting for a given trip. The selection of cruise altitude on the basis of the most favorable wind conditions and the use of low power settings are significant factors that should be considered on every trip to reduce fuel consumption.

For reduced noise levels, it is desirable to select the lowest RPM in the green arc range for a given percent power that will provide smooth engine operation. The cowl flaps should be opened if necessary, to maintain the cylinder head temperature at approximately two-thirds of the normal operating range (green arc).

Cruise performance data in this manual and on the power computer is based on an extended range mixture setting which is approximately one gallon per hour less than the best power mixture setting. This extended range mixture setting results in a one MPH speed loss and an average increase of 6% in range when compared to a best power mixture setting.

For best fuel economy at 55% power or less, the engine may be operated at one gallon per hour leaner than shown in this manual and on the power computer. This will result in approximately 6% greater range than shown in the cruise tables of this manual accompanied by approximately 4 MPH decrease in speed.

The fuel injection system used on this engine is considered to be non-icing. In the event that unusual conditions cause the intake air filter to

TAKE-OFF DATA TAKE-OFF DISTANCE WITH 20° FLAPS FROM HARD SURFACE RUNWAY													
GROSS WEIGHT POUNDS	IAS @50' MPH	HEAD WIND KNOTS	AT SEA LEVEL & 59°F		AT 2500 FT & 50°F		AT 5000 FT & 41°F		AT 7500 FT & 32°F		TOTAL TO CLEAR 50 FT OBS	GROUND RUN	TOTAL TO CLEAR 50 FT OBS
			GROUND RUN	TOTAL TO CLEAR 50 FT OBS	GROUND RUN	TOTAL TO CLEAR 50 FT OBS	GROUND RUN	TOTAL TO CLEAR 50 FT OBS	GROUND RUN	TOTAL TO CLEAR 50 FT OBS			
3350	64	0	770	1365	930	1590	1120	1885	1350	2325	1885	980	1765
		10	540	1030	680	1200	790	1430	980	1765	1430	525	1285
		20	340	730	425	860	525	1030	660	1285	1030	315	825
2800	59	0	515	1025	610	1150	730	1315	885	1530	1155	505	1155
		10	345	755	415	855	505	985	620	1155	855	315	825
		20	205	520	255	600	315	695	400	825	695	180	555
2300	53	0	330	785	395	865	470	965	565	1090	865	310	805
		10	210	570	255	630	310	710	380	805	710	180	555
		20	115	380	145	425	180	485	230	555	485	230	555

NOTES: 1. Increase distance 10% for each 25°F above standard temperature for particular altitude.
2. For operation on a dry, grass runway, increase distances (both "ground run" and "total to clear 50 ft. obstacle") by 6% of the "total to clear 50 ft. obstacle" figure.

MAXIMUM RATE-OF-CLIMB DATA

GROSS WEIGHT POUNDS	AT SEA LEVEL & 59°F		AT 5000 FT & 41°F		AT 10,000 FT & 23°F		AT 15,000 FT & 5°F		AT 20,000 FT & -12°F		FROM S.L. FUEL USED	RATE OF CLIMB FT/MIN.	IAS MPH	FROM S.L. FUEL USED	RATE OF CLIMB FT/MIN.	FROM S.L. FUEL USED
	IAS MPH	RATE OF CLIMB FT/MIN.	IAS MPH	RATE OF CLIMB FT/MIN.	IAS MPH	RATE OF CLIMB FT/MIN.	IAS MPH	RATE OF CLIMB FT/MIN.	IAS MPH	RATE OF CLIMB FT/MIN.						
3350	101	1010	97	750	94	480	7.4	90	215	11.9	11.9	80	150	12.8	8.9	8.9
2800	94	1355	2.5	1050	88	755	5.9	84	435	8.3	8.3	80	150	12.8	8.9	8.9
2300	88	1780	2.5	1425	82	1080	5.0	78	740	6.6	6.6	74	385	8.9	8.9	8.9

NOTES: 1. Full throttle, 2700 RPM, mixture at recommended leaning schedule, flaps up.
2. With full throttle, 2850 RPM, mixture at recommended leaning schedule, rate of climb is increased by 35 ft./min.
3. Fuel used includes warm-up and take-off allowance.
4. For hot weather, decrease rate of climb 30 ft./min for each 10°F above standard day temperature for particular altitude.
5. With cargo pack, climb performance is 40 ft./min less than shown.

Figure 6-3.



STALL SPEEDS - MPH CAS			
GROSS WEIGHT 3350 LBS. CONFIGURATION	ANGLE OF BANK		
	 0°	 30°	 60°
FLAPS UP	65	70	92
FLAPS 20°	58	62	82
FLAPS 40°	56	60	79
POWER OFF - AFT CG			

Figure 6-2.

become clogged or iced over, an alternate intake air valve opens automatically for the most efficient use of either normal or alternate air, depending on the amount of filter blockage. Due to the lower intake pressure available through the alternate air valve or a partially blocked filter, full throttle manifold pressure can decrease approximately 1.5 in. Hg.

LEANING WITH A CESSNA ECONOMY MIXTURE INDICATOR (EGT).

Exhaust gas temperature (EGT) as shown on the optional Cessna Economy Mixture Indicator may be used as an aid for mixture leaning in cruising flight at 75% power or less. To adjust the mixture, using this indicator, lean to establish the peak EGT as a reference point and then enrichen the mixture by a desired increment based on the table below.

Continuous operation at peak EGT is authorized only at 55% power or less. This best economy mixture setting results in approximately 6% greater range than shown in the cruise tables of this manual accompanied by approximately 4 MPH decrease in speed.

NOTE

Operation on the lean side of peak EGT is not approved.

When leaning the mixture, if a distinct peak is not obtained, use the corresponding maximum EGT as a reference point for enrichening the mixture to the desired cruise setting. Any change in altitude or power will require a recheck of the EGT indication.

MIXTURE DESCRIPTION	EXHAUST GAS TEMPERATURE	RANGE INCREASE FROM BEST POWER
BEST POWER	Peak EGT Minus 100°F (Enrichen)	0%
EXTENDED RANGE (Owner's Manual and Computer Performance)	Peak EGT Minus 50°F (Enrichen)	6%
BEST ECONOMY (55% Power or Less)	Peak EGT	12%

STALLS.

The stall characteristics are conventional and aural warning is provided by a stall warning horn which sounds between 5 and 10 MPH above the stall in all configurations.

Power-off stall speeds at maximum gross weight and aft c. g. position are presented in figure 6-2 as calibrated airspeeds, since indicated airspeeds are unreliable near the stall.

LANDING.

Since the ability of the elevator to produce a full stall is dependent upon the adjustable stabilizer being set NOSE UP, it is important that the aircraft be completely trimmed in the approach glide. If the aircraft fails to land three point with the control wheel fully back, it is probable that the adjustable stabilizer is not adjusted for the landing condition.

Landings may be made with the tail wheel lock engaged or disengaged. Although use of the lock is left to the individual pilot's preference, it is probable that its operation will be limited to use during strong crosswind landings on rough fields with a heavily-loaded airplane. This condition would lead to a touchdown with a deflected tail wheel (if the lock were disengaged) and subsequent external forces on the tail wheel that are conducive to shimmy. Engaging the tail wheel lock restrains the steering, making the tail wheel insensitive to rudder pedal action and rocks and ruts on the landing surface.

The landing normally should be three-point. Heavy braking may be used initially in the ground roll if the control wheel is held full back.

For short field landings, make a power-off approach at 78 MPH with 40° flaps, and land three point. Immediately after touchdown, apply heavy braking as required. For maximum brake effectiveness, retract the flaps, hold full nose up elevator and apply maximum possible brake pressure without sliding the tires.

When performing an ILS approach, select an engine speed of less than 2700 RPM to obtain steady and reliable glideslope needle indications. At precisely 2700 RPM a two-bladed propeller may interfere with the glideslope signal, producing erratic glideslope indications.

OPERATIONAL DATA

The operational data charts on the following pages are presented for two purposes: first, so that you may know what to expect from your airplane under various conditions; and second, to enable you to plan your flights in detail and with reasonable accuracy.

The data in the charts has been compiled from actual flight tests with the airplane and engine in good condition and using average piloting techniques. Note also that the range charts make no allowances for wind, navigational errors, warm-up, take-off, climb, etc. You must estimate these variables for yourself and make allowances accordingly.

Remember that the charts contained herein are based on standard day conditions. For more precise power, fuel consumption, and endurance information, consult the Cessna Power Computer supplied with your aircraft. With the Power Computer, you can easily take into account temperature variations from standard at any flight altitude.

AIRSPED CORRECTION TABLE							
FLAPS 0°							
IAS - MPH	60	80	100	120	140	160	180
CAS - MPH	64	82	100	119	139	158	177
*FLAPS DOWN							
IAS - MPH	50	60	70	80	90	100	110
CAS - MPH	58	65	74	83	93	102	112
* MAXIMUM FLAP SPEED 110 MPH, CAS							

Figure 6-1.

BALKED LANDING

In a bailed landing (go-around) climb, the wing flap setting should be reduced to 20° immediately after full power is applied. After all obstacles are cleared and a safe altitude and airspeed are obtained, the wing flaps should be retracted and the cowl flaps opened.

COLD WEATHER OPERATION.

The use of external preheater (for both the engine and battery) and an external power source is recommended whenever possible to reduce wear and abuse to the engine and the electrical system.

Preheat will thaw the oil trapped in the oil cooler, which probably will be congealed prior to starting in extremely cold temperatures. When using an external power source, the position of the master switch is important. Refer to Section VII, paragraph Ground Service Plug Receptacle, for operating details.

During cold weather operations, no indication need be apparent on the oil temperature gage prior to take-off. After a suitable warm-up period (2 to 5 minutes at 1000 RPM), the engine is ready for take-off if it accelerates smoothly and the oil pressure is normal and steady.

During let-down, observe engine temperatures closely and carry sufficient power to maintain them in the recommended operating range.

NOISE ABATEMENT.

Increased emphasis on improving the quality of our environment requires renewed effort on the part of all pilots to minimize the effect of aircraft noise on the public.

We, as pilots, can demonstrate our concern for environmental improvement, by application of the following suggested procedures, and thereby tend to build public support for aviation:

- (1) Pilots operating aircraft under VFR over outdoor assemblies of persons, recreational and park areas, and other noise-sensitive areas should make every effort to fly not less than 2,000 feet above

the surface, weather permitting, even though flight at a lower level may be consistent with the provisions of government regulations.

(2) During departure from or approach to an airport, climb after take-off and descent for landing should be made so as to avoid prolonged flight at low altitude near noise-sensitive areas.

NOTE

The above recommended procedures do not apply where they would conflict with Air Traffic Control clearances or instructions, or where, in the pilot's judgment, an altitude of less than 2,000 feet is necessary for him to adequately exercise his duty to see and avoid other aircraft.

OWNER FOLLOW-UP SYSTEM.

Your Cessna Dealer has an Owner Follow-Up System to notify you when he receives information that applies to your Cessna. In addition, if you wish, you may choose to receive similar notification, in the form of Service Letters, directly from the Cessna Customer Services Department. A subscription form is supplied in your Customer Care Program book for your use, should you choose to request this service. Your Cessna Dealer will be glad to supply you with details concerning these follow-up programs, and stands ready, through his Service Department, to supply you with fast, efficient, low-cost service.

PUBLICATIONS.

Various publications and flight operation aids are furnished in the aircraft when delivered from the factory. These items are listed below.

- CUSTOMER CARE PROGRAM BOOK
- OWNER'S MANUALS FOR YOUR
AIRCRAFT
AVIONICS AND AUTOPILOT
- POWER COMPUTER
- SALES AND SERVICE DEALER DIRECTORY
- DO'S AND DON'TS ENGINE BOOKLET

The following additional publications, plus many other supplies that are applicable to your aircraft, are available from your Cessna Dealer.

- SERVICE MANUALS AND PARTS CATALOGS FOR YOUR
AIRCRAFT
ENGINE AND ACCESSORIES
AVIONICS AND AUTOPILOT

Your Cessna Dealer has a current catalog of all Customer Services Supplies that are available, many of which he keeps on hand. Supplies which are not in stock, he will be happy to order for you.

inspection within the first 6 months of ownership at no charge to you. If you take delivery from your Dealer, the initial inspection will have been performed before delivery of the aircraft to you. If you pick up your aircraft at the factory, plan to take it to your Dealer reasonably soon after you take delivery, so the initial inspection may be performed allowing the Dealer to make any minor adjustments which may be necessary.

You will also want to return to your Dealer either at 50 hours for your first Progressive Care Operation, or at 100 hours for your first 100-hour inspection depending on which program you choose to establish for your aircraft. While these important inspections will be performed for you by any Cessna Dealer, in most cases you will prefer to have the Dealer from whom you purchased the aircraft accomplish this work.

SERVICING REQUIREMENTS.

For quick and ready reference, quantities, materials, and specifications for frequently used service items (such as fuel, oil, etc.) are shown on the inside back cover of this manual.

In addition to the EXTERIOR INSPECTION covered in Section I, COMPLETE servicing, inspection, and test requirements for your aircraft are detailed in the aircraft Service Manual. The Service Manual outlines all items which require attention at 50, 100, and 200 hour intervals plus those items which require servicing, inspection, and/or testing at special intervals.

Since Cessna Dealers conduct all service, inspection, and test procedures in accordance with applicable Service Manuals, it is recommended that you contact your Dealer concerning these requirements and begin scheduling your aircraft for service at the recommended intervals.

Cessna Progressive Care ensures that these requirements are accomplished at the required intervals to comply with the 100-hour or ANNUAL inspection as previously covered.

Depending on various flight operations, your local Government Aviation Agency may require additional service, inspections, or tests. For these regulatory requirements, owners should check with local aviation officials where the aircraft is being operated.

EMERGENCY PROCEDURES

Emergencies caused by aircraft or engine malfunctions are extremely rare if proper pre-flight inspections and maintenance are practiced. Enroute weather emergencies can be minimized or eliminated by careful flight planning and good judgement when unexpected weather is encountered. However, should an emergency arise, the basic guidelines described in this section should be considered and applied as necessary to correct the problem.

ENGINE FAILURE.

ENGINE FAILURE AFTER TAKE-OFF.

Prompt lowering of the nose to maintain airspeed and establish a glide attitude is the first response to an engine failure after take-off. In most cases, the landing should be planned straight ahead with only small changes in direction to avoid obstructions. Altitude and airspeed are seldom sufficient to execute a 180° gliding turn necessary to return to the runway. The following procedures assume that adequate time exists to secure the fuel and ignition systems prior to touchdown.

- (1) Airspeed -- 85 MPH.
- (2) Mixture -- IDLE CUT-OFF.
- (3) Fuel Shutoff Valve -- OFF.
- (4) Ignition Switch -- OFF.
- (5) Master Switch -- OFF.
- (6) Wing Flaps -- AS REQUIRED (40° recommended).

ENGINE FAILURE DURING FLIGHT.

While gliding toward a suitable landing area, an effort should be made to identify the cause of the failure. If time permits, and an engine restart is feasible, proceed as follows:

- (1) Airspeed -- 90 MPH.

- (2) Fuel Shutoff Valve -- ON.
- (3) Fuel Selector Valve (if installed) -- BOTH ON.
- (4) Mixture -- RICH.
- (5) Throttle -- CRACKED 1 INCH.
- (6) Primer -- IN and LOCKED.
- (7) Auxiliary Fuel Pump -- ON to obtain 4 - 6 GPH, then OFF.
- (8) Ignition Switch -- BOTH (or START if propeller is not wind-milling).

If the engine cannot be restarted, a forced landing without power must be executed. A recommended procedure for this is given in the following paragraph.

FORCED LANDINGS.

EMERGENCY LANDING WITHOUT ENGINE POWER.

If all attempts to restart the engine fail and a forced landing is imminent, select a suitable field and prepare for the landing as follows:

- (1) Airspeed -- 90 MPH (flaps UP),
80 MPH (flaps DOWN).
- (2) Mixture -- IDLE CUT-OFF.
- (3) Fuel Shutoff Valve -- OFF.
- (4) Ignition Switch -- OFF.
- (5) Master Switch -- OFF.
- (6) Wing Flaps -- AS REQUIRED (40° recommended).
- (7) Doors -- UNLATCH PRIOR TO APPROACH.
- (8) Touchdown -- 3-POINT ATTITUDE.
- (9) Brakes -- APPLY HEAVILY.

PRECAUTIONARY LANDING WITH ENGINE POWER.

Before attempting an "off airport" landing, one should drag the landing area at a safe but low altitude to inspect the terrain for obstructions and surface conditions, proceeding as follows:

- (1) Drag over selected field with flaps 20° and 90 MPH airspeed, noting the preferred area for touchdown for the next landing approach. Then retract flaps upon reaching a safe altitude and airspeed.
- (2) Radio, Electrical Switches -- OFF.
- (3) Wing Flaps -- 40°.
- (4) Airspeed -- 80 MPH.

In lieu of the above requirements, an aircraft may be inspected in accordance with a progressive inspection schedule, which allows the work load to be divided into smaller operations that can be accomplished in shorter time periods.

The CESSNA PROGRESSIVE CARE PROGRAM has been developed to provide a modern progressive inspection schedule that satisfies the complete aircraft inspection requirements of both the 100 HOUR and ANNUAL inspections as applicable to Cessna aircraft.

CESSNA PROGRESSIVE CARE.

The Cessna Progressive Care Program has been designed to help you realize maximum utilization of your aircraft at a minimum cost and downtime. Under this program, your aircraft is inspected and maintained in four operations at 50-hour intervals during a 200-hour period. The operations are recycled each 200 hours and are recorded in a specially provided Aircraft Inspection Log as each operation is conducted.

The Cessna Aircraft Company recommends Progressive Care for aircraft that are being flown 200 hours or more per year, and the 100-hour inspection for all other aircraft. The procedures for the Progressive Care Program and the 100-hour inspection have been carefully worked out by the factory and are followed by the Cessna Dealer Organization. The complete familiarity of Cessna Dealers with Cessna equipment and factory-approved procedures provides the highest level of service possible at lower cost to Cessna owners.

CESSNA CUSTOMER CARE PROGRAM.

Specific benefits and provisions of the CESSNA WARRANTY plus other important benefits for you are contained in your CUSTOMER CARE PROGRAM book supplied with your aircraft. You will want to thoroughly review your Customer Care Program book and keep it in your aircraft at all times.

Coupons attached to the Program book entitle you to an initial inspection and either a Progressive Care Operation No. 1 or the first 100-hour

Cessna recommends that these items, plus the Owner's Manual, Power Computer, Pilot's Checklist, Customer Care Program book and Customer Care Card, be carried in the aircraft at all times.

FLYABLE STORAGE.

Aircraft placed in non-operational storage for a maximum of 30 days or those which receive only intermittent operational use for the first 25 hours are considered in flyable storage status. Every seventh day during these periods, the propeller should be rotated by hand through five revolutions. This action "limbers" the oil and prevents any accumulation of corrosion on engine cylinder walls.

IMPORTANT

For maximum safety, check that the ignition switch is OFF, the throttle is closed, the mixture control is in the idle cut-off position, and the airplane is secured before rotating the propeller by hand. Do not stand within the arc of the propeller blades while turning the propeller.

After 30 days, the aircraft should be flown for 30 minutes or a ground runup should be made just long enough to produce an oil temperature within the lower green arc range. Excessive ground runup should be avoided.

Engine runup also helps to eliminate excessive accumulations of water in the fuel system and other air spaces in the engine. Keep fuel tanks full to minimize condensation in the tanks. Keep the battery fully charged to prevent the electrolyte from freezing in cold weather. If the aircraft is to be stored temporarily, or indefinitely, refer to the Service Manual for proper storage procedures.

INSPECTION REQUIREMENTS.

As required by Federal Aviation Regulations, all civil aircraft of U.S. registry must undergo a complete inspection (annual) each twelve calendar months. In addition to the required ANNUAL inspection, aircraft operated commercially (for hire) must have a complete inspection every 100 hours of operation.

- (5) Master Switch -- OFF.
- (6) Doors -- UNLATCH PRIOR TO APPROACH.
- (7) Touchdown -- 3-POINT ATTITUDE.
- (8) Ignition Switch -- OFF.
- (9) Brakes -- APPLY HEAVILY.

DITCHING.

Prepare for ditching by securing or jettisoning heavy objects located in the baggage area, and collect folded coats or cushions for protection of occupant's face at touchdown. Transmit Mayday message on 121.5 MHz, giving location and intentions.

- (1) Plan approach into wind if winds are high and seas are heavy. With heavy swells and light wind, land parallel to swells.
- (2) Approach with flaps 40° and sufficient power for a 300 ft./min. rate of descent at 80 MPH.
- (3) Unlatch the cabin doors.
- (4) Maintain a continuous descent until touchdown in a tail-low attitude. Avoid a landing flare because of difficulty in judging aircraft height over a water surface.
- (5) Place folded coat or cushion in front of face at time of touchdown.
- (6) Evacuate aircraft through cabin doors. If necessary, open window to flood cabin compartment for equalizing pressure so that door can be opened.
- (7) Inflate life vests and raft (if available) after evacuation of cabin. The aircraft cannot be depended on for flotation for more than a few minutes.

FIRES.

ENGINE FIRE IN FLIGHT.

Although engine fires are extremely rare in flight, the following steps should be taken if one is encountered:

- (1) Fuel Shutoff Valve -- OFF.
- (2) Mixture -- IDLE CUT-OFF.
- (3) Master Switch -- OFF.
- (4) Cabin Heat and Air -- OFF (except overhead vents).
- (5) Airspeed -- 120 MPH. If fire is not extinguished, increase glide speed to find an airspeed which will provide an incombustible mixture.

- (6) Select a field suitable for a forced landing.
- (7) Execute a forced landing as described in paragraph EMERGENCY LANDING WITHOUT ENGINE POWER. Do not attempt to restart engine.

ELECTRICAL FIRE IN FLIGHT.

The initial indication of an electrical fire is usually the odor of burning insulation. The following procedure should then be used:

- (1) Master Switch -- OFF.
- (2) All Radio/Electrical Switches -- OFF.
- (3) Vents/Cabin Air/Heat -- CLOSED.
- (4) Fire Extinguisher -- ACTIVATE (if available).

If fire appears out and electrical power is necessary for continuance of flight:

- (5) Master Switch -- ON.
- (6) Circuit Breakers -- CHECK for faulty circuit, do not reset.
- (7) Radio/Electrical Switches -- ON one at a time, with delay after each until short circuit is localized.
- (8) Vents/Cabin Air/Heat -- OPEN when it is ascertained that fire is completely extinguished.

DISORIENTATION IN CLOUDS.

In the event of a vacuum system failure during flight in marginal weather, the directional gyro and gyro horizon will be disabled, and the pilot will have to rely on the turn coordinator or the turn and bank indicator if he inadvertently flies into clouds. The following instructions assume that only the electrically-powered turn coordinator or the turn and bank indicator is operative, and that the pilot is not completely proficient in partial panel instrument flying.

EXECUTING A 180° TURN IN CLOUDS.

Upon entering the clouds, an immediate plan should be made to turn back as follows:

- (1) Note the time of the minute hand and observe the position of the sweep second hand on the clock.
- (2) When the sweep second hand indicates the nearest half-minute,

MAA PLATE/FINISH AND TRIM PLATE.

Information concerning the Type Certificate Number (TC), Production Certificate Number (PC), Model Number and Serial Number of your particular aircraft can be found on the MAA (Manufacturers Aircraft Association) plate located on the left forward doorpost.

A Finish and Trim Plate contains a code describing the interior color scheme and exterior paint combination of the aircraft. The code may be used in conjunction with an applicable Parts Catalog if finish and trim information is needed. This plate is located adjacent to the MAA plate on the left forward doorpost.

AIRCRAFT FILE.

There are miscellaneous data, information and licenses that are a part of the aircraft file. The following is a checklist for that file. In addition, a periodic check should be made of the latest Federal Aviation Regulations to ensure that all data requirements are met.

- A. To be displayed in the aircraft at all times:
 - (1) Aircraft Airworthiness Certificate (FAA Form 8100-2).
 - (2) Aircraft Registration Certificate (FAA Form 8050-3).
 - (3) Aircraft Radio Station License, if transmitter installed (FCC Form 556).

- B. To be carried in the aircraft at all times:
 - (1) Weight and Balance, and associated papers (latest copy of the Repair and Alteration Form, FAA Form 337, if applicable).
 - (2) Aircraft Equipment List.

- C. To be made available upon request:
 - (1) Aircraft Log Book.
 - (2) Engine Log Book.

Most of the items listed are required by the United States Federal Aviation Regulations. Since the regulations of other nations may require other documents and data, owners of exported aircraft should check with their own aviation officials to determine their individual requirements.

INTERIOR CARE.

The standard interior of your aircraft is furnished with wear-resistant, hard surface materials designed for maximum usage with minimum upkeep. However, as with any furnishing, the measure of lasting appearance and endurance afforded by the interior is dependent upon the degree of care.

Materials used on the cabin floor and sidewalls are not easily soiled or stained. Dust and loose dirt should be picked up with a vacuum cleaner. Stubborn dirt can be wiped off with a cloth moistened in clean water. Mild soap suds, used sparingly, will remove grease. The soap should be removed with a clean damp cloth.

Care of the seating materials is identical to care of the furnishings in your home. Vacuum clean the seats regularly to remove dust and loose dirt.

Blot up any spilled liquid promptly, with cleansing tissue or rags. Don't pat the spot; press the blotting material firmly and hold it for several seconds. Continue blotting until no more liquid is taken up. Scrape off sticky materials with a dull knife, then spot-clean the area.

Oily spots may be cleaned with household spot removers, used sparingly. Before using any solvent, read the instructions on the container and test it on an obscure place on the fabric to be cleaned. Never saturate the fabric with a volatile solvent; it may damage the padding and backing materials.

Soiled upholstery and carpeting (if installed) may be cleaned with foam-type detergent, used according to the manufacturer's instructions. Keep the foam as dry as possible and remove it with a vacuum cleaner.

If your aircraft is equipped with leather seating, cleaning of the seats is accomplished using a soft cloth or sponge dipped in mild soap suds. The soap suds, used sparingly, will remove traces of dirt and grease. The soap should be removed with a clean damp cloth.

The headliner, instrument panel, plastic trim and control knobs need only be wiped off with a damp cloth. Oil and grease on the control wheel and control knobs can be removed with a cloth moistened with Stoddard solvent. Volatile solvents, such as mentioned in paragraphs on care of the windshield, must never be used since they will soften and craze the plastic.

initiate a standard rate left turn, holding the turn coordinator symbolic aircraft wing opposite the lower left index mark for 60 seconds. Then roll back to level flight by leveling the miniature aircraft.

(3) Check accuracy of the turn by observing the compass heading which should be the reciprocal of the original heading.

(4) If necessary, adjust heading primarily with skidding motions rather than rolling motions so that the compass will read more accurately.

(5) Maintain altitude and airspeed by cautious application of elevator control. Avoid overcontrolling by keeping the hands off the control wheel and steering only with rudder.

EMERGENCY LET-DOWNS THROUGH CLOUDS.

If possible, obtain radio clearance for an emergency descent through clouds. To guard against a spiral dive, choose an easterly or westerly heading to minimize compass card swings due to changing bank angles. In addition, keep hands off the control wheel and steer a straight course with rudder control by monitoring the turn coordinator. Occasionally check the compass heading and make minor corrections to hold an approximate course. Before descending into the clouds, set up a stabilized let-down condition as follows:

- (1) Reduce power to set up a 500 to 800 ft./min. rate of descent.
- (2) Adjust the stabilizer trim control for a stabilized descent at 110 MPH.
- (3) Keep hands off the control wheel.
- (4) Monitor turn coordinator and make corrections by rudder alone.
- (5) Check trend of compass card movement and make cautious corrections with rudder to stop the turn.
- (6) Upon breaking out of clouds, resume normal cruising flight.

RECOVERY FROM A SPIRAL DIVE.

If a spiral is encountered, proceed as follows:

- (1) Close the throttle.
- (2) Stop the turn by using coordinated aileron and rudder control to align the symbolic aircraft in the turn coordinator with the horizon reference line.
- (3) Cautiously apply elevator back pressure to slowly reduce the indicated airspeed to 110 MPH.
- (4) Adjust the stabilizer trim control to maintain a 110 MPH glide.
- (5) Keep hands off the control wheel, using rudder control to hold a

straight heading.

- (6) Clear engine occasionally, but avoid using enough power to disturb the trimmed glide.
- (7) Upon breaking out of clouds, apply normal cruising power and resume flight.

SPINS.

Intentional spins are prohibited in this aircraft. Should an inadvertent spin occur, the following recovery procedure should be employed.

- (1) Retard power to idle position.
- (2) Apply full rudder opposite to the direction of rotation.
- (3) After one-fourth turn, move the control wheel forward of neutral in a brisk motion.
- (4) As rotation stops, neutralize rudder, and make a smooth recovery from the resulting dive.

FLIGHT IN ICING CONDITIONS.

Although flying in known icing conditions is prohibited, an unexpected icing encounter should be handled as follows:

- (1) Turn pitot heat switch ON (if installed).
- (2) Turn back or change altitude to obtain an outside air temperature that is less conducive to icing.
- (3) Pull cabin heat control full out to obtain windshield defroster airflow. Adjust cabin air control to get maximum defroster heat and airflow.
- (4) Increase engine speed to minimize ice build-up on propeller blades.
- (5) Watch for signs of induction air filter ice and regain manifold pressure by increasing throttle setting.

NOTE

If ice accumulates on the intake filter (causing the alternate air valve to open) a decrease of 1 to 2 inches of full throttle manifold pressure will be experienced.

PAINTED SURFACES.

The painted exterior surfaces of your new Cessna have a durable, long lasting finish and, under normal conditions, require no polishing or buffing. Approximately 15 days are required for the paint to cure completely; in most cases, the curing period will have been completed prior to delivery of the aircraft. In the event that polishing or buffing is required within the curing period, it is recommended that the work be done by someone experienced in handling uncured paint. Any Cessna Dealer can accomplish this work.

Generally, the painted surfaces can be kept bright by washing with water and mild soap, followed by a rinse with water and drying with cloths or a chamois. Harsh or abrasive soaps or detergents which cause corrosion or scratches should never be used. Remove stubborn oil and grease with a cloth moistened with Stoddard solvent.

Waxing is unnecessary to keep the painted surfaces bright. However, if desired, the aircraft may be waxed with a good automotive wax. A heavier coating of wax on the leading edges of the wings and tail and on the engine nose cap and propeller spinner will help reduce the abrasion encountered in these areas.

When the aircraft is parked outside in cold climates and it is necessary to remove ice before flight, care should be taken to protect the painted surfaces during ice removal with chemical liquids. A 50-50 solution of isopropyl alcohol and water will satisfactorily remove ice accumulations without damaging the paint. A solution with more than 50% alcohol is harmful and should be avoided. While applying the de-icing solution, keep it away from the windshield and cabin windows since the alcohol will attack the plastic and may cause it to craze.

PROPELLER CARE.

Preflight inspection of propeller blades for nicks, and wiping them occasionally with an oily cloth to clean off grass and bug stains will assure long, trouble-free service. Small nicks on the propeller, particularly near the tips and on the leading edges, should be dressed out as soon as possible since these nicks produce stress concentrations, and if ignored, may result in cracks. Never use an alkaline cleaner on the blades; remove grease and dirt with carbon tetrachloride or Stoddard solvent.

WINDSHIELD — WINDOWS.

The plastic windshield and windows should be cleaned with an aircraft windshield cleaner. Apply the cleaner sparingly with soft cloths, and rub with moderate pressure until all dirt, oil scum and bug stains are removed. Allow the cleaner to dry, then wipe it off with soft flannel cloths.

If a windshield cleaner is not available, the plastic can be cleaned with soft cloths moistened with Stoddard solvent to remove oil and grease.

NOTE

Never use gasoline, benzine, alcohol, acetone, carbon tetrachloride, fire extinguisher or anti-ice fluid, lacquer thinner or glass cleaner to clean the plastic. These materials will attack the plastic and may cause it to craze.

Follow by carefully washing with a mild detergent and plenty of water. Rinse thoroughly, then dry with a clean moist chamois. Do not rub the plastic with a dry cloth since this builds up an electrostatic charge which attracts dust. Waxing with a good commercial wax will finish the cleaning job. A thin, even coat of wax, polished out by hand with clean soft flannel cloths, will fill in minor scratches and help prevent further scratching.

Do not use a canvas cover on the windshield unless freezing rain or sleet is anticipated since the cover may scratch the plastic surface.

ALUMINUM SURFACES.

The clad aluminum surfaces of your Cessna may be washed with clear water to remove dirt; oil and grease may be removed with gasoline, naphtha, carbon tetrachloride or other non-alkaline solvents. Dulled aluminum surfaces may be cleaned effectively with an aircraft aluminum polish.

After cleaning, and periodically thereafter, waxing with a good automotive wax will preserve the bright appearance and retard corrosion. Regular waxing is especially recommended for airplanes operated in salt water areas as a protection against corrosion.

- (6) Plan a landing at the nearest airport. With an extremely rapid ice build-up, select a suitable "off airport" landing site.
- (7) With an ice accumulation of 1/4 inch or more on the wing leading edges, be prepared for significantly higher stall speed.
- (8) Leave wing flaps retracted. With a severe ice build-up on the horizontal tail, the change in wing wake airflow direction caused by wing flap extension could result in a loss of elevator effectiveness.
- (9) Open left window and, if practical, scrape ice from a portion of the windshield for visibility in the landing approach.
- (10) Perform a landing approach using a forward slip, if necessary, for improved visibility.
- (11) Approach at 90 to 100 MPH, depending upon the amount of ice accumulation.
- (12) Perform a wheel landing at a speed slightly higher than normal.

ROUGH ENGINE OPERATION OR LOSS OF POWER.

SPARK PLUG FOULING.

A slight engine roughness in flight may be caused by one or more spark plugs becoming fouled by carbon or lead deposits. This may be verified by turning the ignition switch momentarily from BOTH to either L or R position. An obvious power loss in single ignition operation is evidence of spark plug or magneto trouble. Assuming that spark plugs are the more likely cause, lean the mixture to the normal lean setting for cruising flight. If the problem does not clear up in several minutes, determine if a richer mixture setting will produce smoother operation. If not, proceed to the nearest airport for repairs using the BOTH position of the ignition switch unless extreme roughness dictates the use of a single ignition position.

MAGNETO MALFUNCTION.

A sudden engine roughness or misfiring is usually evidence of magneto problems. Switching from BOTH to either L or R ignition switch position will identify which magneto is malfunctioning. Select different power settings and enrichen the mixture to determine if continued operation on BOTH magnetos is practicable. If not, switch to the good magneto and proceed to the nearest airport for repairs.

ENGINE-DRIVEN FUEL PUMP FAILURE.

Failure of the engine-driven fuel pump will be evidenced by sudden reduction in the fuel flow indication prior to a loss of power, while operating from a fuel tank containing adequate fuel.

In the event of an engine-driven fuel pump failure during take-off immediately hold the left half of the auxiliary fuel pump switch in the HI position until the aircraft is well clear of obstacles. Upon reaching a safe altitude, release the HI switch. The ON position will then provide sufficient fuel flow to maintain engine operation while maneuvering for a landing.

If an engine-driven fuel pump failure occurs during cruising flight, apply full rich mixture and hold the left half of the auxiliary fuel pump switch in the HI position. Dependent upon power setting and altitude the normal ON position of the right half of the fuel pump switch may provide sufficient fuel flow to sustain proper engine operation. If necessary, additional fuel flow is obtainable by holding the left half of the pump switch in the HI position.

LOW OIL PRESSURE

If low oil pressure is accompanied by normal oil temperature, there is a possibility the oil pressure gage or relief valve is malfunctioning. A leak in the line to the gage is not necessarily cause for an immediate precautionary landing because an orifice in this line will prevent a sudden loss of oil from the engine sump. However, a landing at the nearest airport would be advisable to inspect the source of trouble.

If a total loss of oil pressure is accompanied by a rise in oil temperature, there is good reason to suspect an engine failure is imminent. Reduce engine power immediately and select a suitable forced landing field. Leave the engine running at low power during the approach, using only the minimum power required to reach the desired touchdown spot.

ELECTRICAL POWER SUPPLY SYSTEM MALFUNCTIONS.

Malfunctions in the electrical power supply system can be detected by

Section V

CARE OF THE AIRPLANE

If your aircraft is to retain that new-plane performance and dependability, certain inspection and maintenance requirements must be followed. It is wise to follow a planned schedule of lubrication and preventive maintenance based on climatic and flying conditions encountered in your locality.

Keep in touch with your Cessna Dealer, and take advantage of his knowledge and experience. He knows your aircraft and how to maintain it. He will remind you when lubrications and oil changes are necessary, and about other seasonal and periodic services.

GROUND HANDLING.

When maneuvering the aircraft by hand, push at the front spar of the stabilizer adjacent to the fuselage, at the root of the dorsal fin, and at the landing gear or strut root fitting. Do not lift the empennage by the tip of the elevator; likewise, do not shove sideways on the upper portion of the fin.

MOORING YOUR AIRPLANE.

Proper tie-down procedure is your best precaution against damage to your parked aircraft by gusty or strong winds. To tie-down your aircraft securely, proceed as follows:

- (1) Set the parking brake and install the control wheel lock.
- (2) Install a surface control lock over the fin and rudder.
- (3) Tie a rope or chain to the tail gear tie-down fitting and secure the opposite end to a tie-down.
- (4) Tie sufficiently strong ropes or chains (700 pounds tensile strength) to the wing tie-down fittings, and secure the opposite ends of the ropes or chains to tie-downs.
- (5) Install a pitot tube cover.

CARGO PACK

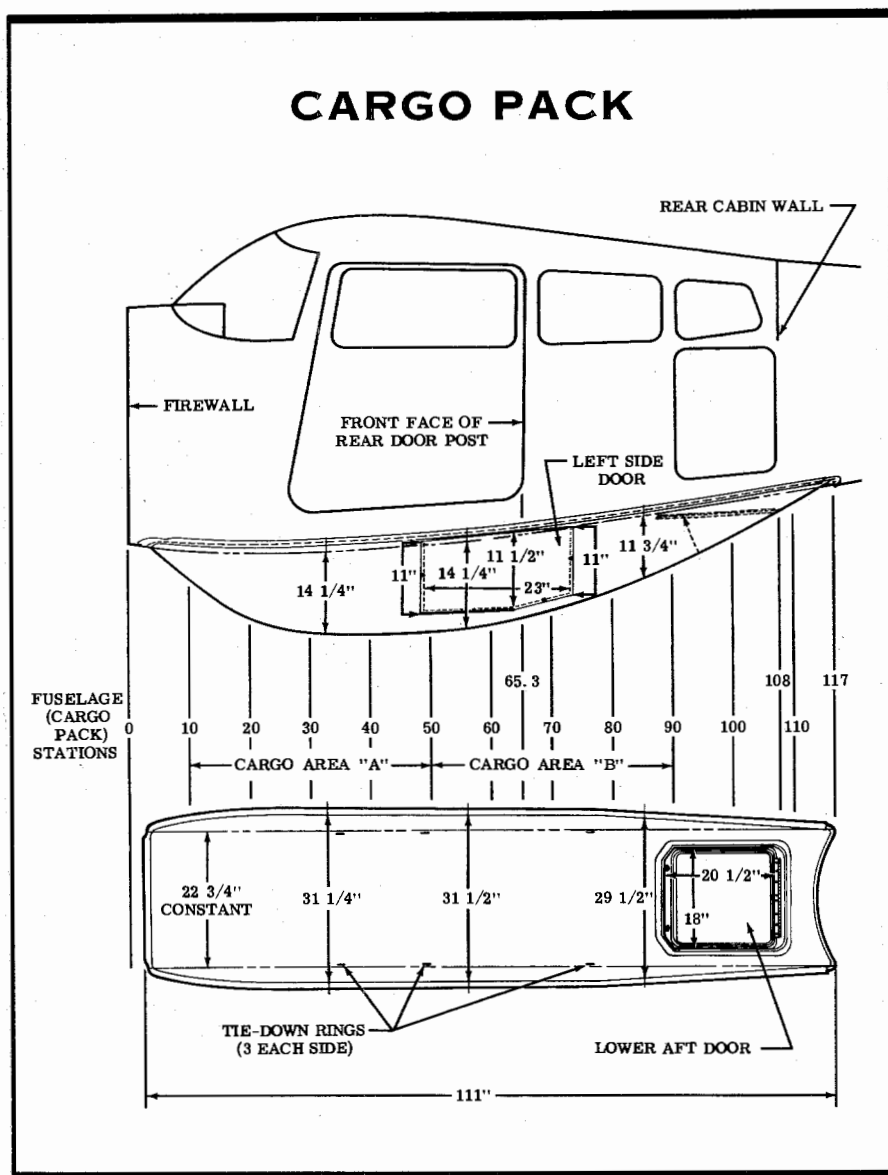

periodic monitoring of the ammeter and over-voltage warning light; however, the cause of these malfunctions is usually difficult to determine. A broken alternator drive belt or loose alternator wiring is most likely the cause of alternator failures, although other factors could cause the problem. A damaged or improperly adjusted voltage regulator can also cause malfunctions. Problems of this nature constitute an electrical emergency and should be dealt with immediately. Electrical power malfunctions usually fall into two categories: excessive rate of charge and insufficient rate of charge. The paragraphs below describe the recommended remedy for each situation.

EXCESSIVE RATE OF CHARGE.

After engine starting and heavy electrical usage at low engine speeds (such as extended taxiing) the battery condition will be low enough to accept above normal charging during the initial part of a flight. However, after thirty minutes of cruising flight, the ammeter should be indicating less than two needle widths of charging current. If the charging rate were to remain above this value on a long flight, the battery would overheat and evaporate the electrolyte at an excessive rate. Electronic components in the electrical system could be adversely affected by higher than normal voltage if a faulty voltage regulator setting is causing the overcharging. To preclude these possibilities, an over-voltage sensor will automatically shut down the alternator and the over-voltage warning light will illuminate if the charge voltage reaches approximately 16 volts. Assuming that the malfunction was only momentary, an attempt should be made to reactivate the alternator system. To do this, turn both sides of the master switch off and then on again. If the problem no longer exists, normal alternator charging will resume and the warning light will go off. If the light comes on again, a malfunction is confirmed. In this event, the flight should be terminated and/or the current drain on the battery minimized because the battery can supply the electrical system for only a limited period of time. If the emergency occurs at night, power must be conserved for later use of the landing lights during landing.

INSUFFICIENT RATE OF CHARGE.

If the ammeter indicates a continuous discharge rate in flight, the alternator is not supplying power to the system and should be turned OFF since the alternator field circuit may be placing an unnecessary load on the system. All non-essential equipment should be turned OFF and the flight terminated as soon as practical.

ELT CONTROL PANEL

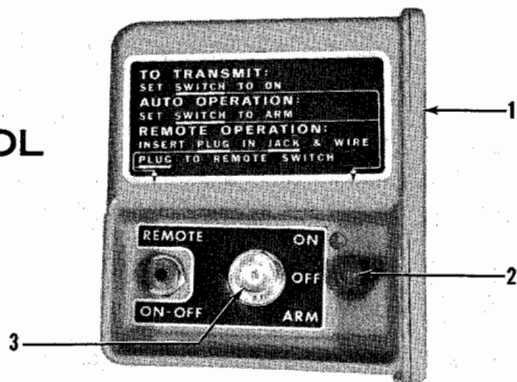

1. COVER - Removable for access to battery.
2. FUNCTION SELECTOR SWITCH (3-position toggle switch):
 - ON - Activates transmitter instantly. Used for test purposes and if "g" switch is inoperative.
 - OFF - Deactivated transmitter. Used during shipping, storage and following rescue.
 - ARM - Activates transmitter only when "g" switch receives 5g or more impart.
3. ANTENNA RECEPTACLE - Connection to antenna mounted on top of the tailcone.

Figure 3-1.

EMERGENCY LOCATOR TRANSMITTER (ELT).

The ELT consists of a self-contained dual-frequency radio transmitter and battery power supply, and is activated by an impact of 5g or more as may be experienced in a crash landing. The ELT emits an omnidirectional signal on the international distress frequencies of 121.5 and 243.0 MHz. General aviation and commercial aircraft, the FAA, and CAP monitor 121.5 MHz, and 243.0 MHz is monitored by the military. Fol-

CARGO LOADING

Since your Cessna is capable of carrying large amounts of cargo, it will be necessary to properly secure this load before flight. An optional tie-down kit is available from any Cessna dealer. Provided in this kit are 6 tie-down blocks that fasten to the seat rails. If more tie-down points are needed, the seat belt attaching points, as well as shoulder harness attaching points, may be used. Rope, strap, or cable used for tie-down should be rated at a minimum of ten times the load weight capacity of the tie-down fittings used.

The following table shows the maximum allowable cargo weight for each type of attachment:

ITEM	LOCATION	*MAXIMUM LOAD (LBS.)
Seat Rail Tie-Down Assy	On Seat Rail Section Without Lock Pin Holes	200
Seat Rail Tie-Down Assy	On Seat Rail Section With Lock Pin Holes	100
Seat Belt Attachment	Floor or Side-Wall	200
Shoulder Strap	Cabin Top	175
"D" Ring Tie-Down	Floor	60

*Rated load per attachment (Cargo Item Wt. ÷ No. Tie-Downs). A sufficient number of attachments to restrain the cargo from shifting should be used in addition to load requirements.

FOR EXAMPLE:

A 400# load would require a minimum of four (4) tie-downs rated at 100# each.

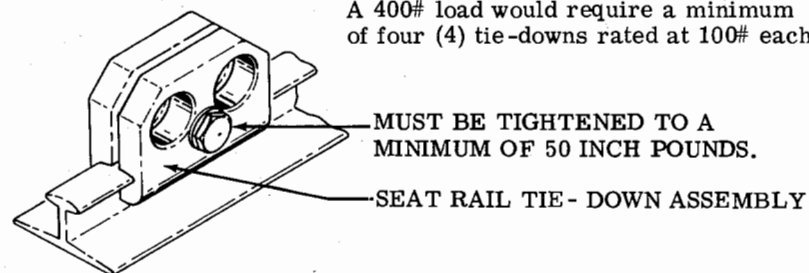

INTERNAL CABIN DIMENSIONS FOR CARGO LOADING

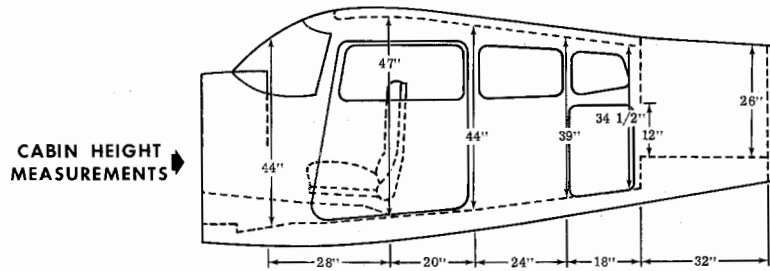

WIDTH

- * CABIN FLOOR
- LWR. WINDOW LINE

DOOR OPENING DIMENSIONS

	WIDTH (TOP)	WIDTH (BOTTOM)	HEIGHT (FRONT)	HEIGHT (REAR)
CABIN DOOR	32"	37"	41"	38 1/2"
BAGGAGE DOOR	15 1/4"	15 1/2"	22 1/4"	21"

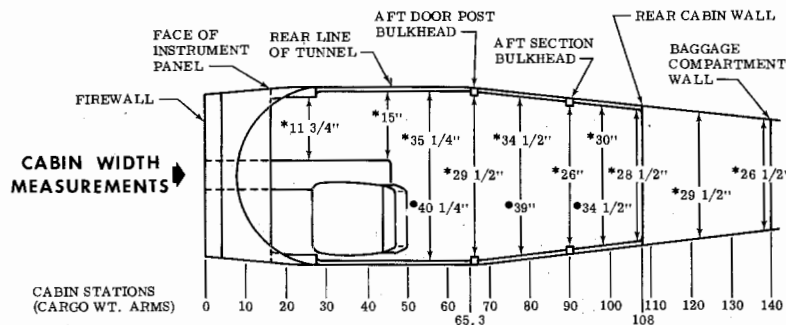

NOTES:

1. Use the forward face of the rear door post as a reference point to locate C. G. arms. For example, a box with its center of weight located 13 inches forward of the rear door post would have a C. G. arm of (65.3-13.0 = 52.3) 52.3 inches.
2. Maximum allowable cabin floor loading: 200 pounds/square foot. However, when items with small or sharp support areas are carried, the installation of a 1/4" spruce or fir plywood floor is highly recommended to protect the aircraft structure.
3. A maximum of 120 pounds of baggage is permitted in Baggage Area 1 when using the baggage net.
4. A maximum of 50 pounds of baggage is permitted in Baggage Area 2.

Following a crash landing, the ELT will provide line-of-sight transmission up to 100 miles at 10,000 feet. The duration of ELT transmissions is affected by ambient temperature. At temperatures of +70° to +130°F, continuous transmission for 115 hours can be expected; a temperature of -40°F will shorten the duration to 70 hours.

The ELT is readily identified as a bright orange unit mounted behind the baggage compartment wall on the top of the tailcone. To gain access to the unit, grasp the edge of the baggage wall and pull. The ELT is operated by a control panel at the forward facing end of the unit (see figure 3-1).

ELT OPERATION.

- (1) **NORMAL OPERATION:** As long as the function selector switch remains in the ARM position, the ELT automatically activates following an impact of 5g or more over a short time period.
- (2) **ELT FAILURE:** If "g" switch actuation is questioned following a minor crash landing, gain access to the ELT and place the function selector switch in the ON position.
- (3) **PRIOR TO SIGHTING RESCUE AIRCRAFT:** Conserve aircraft battery. Do not activate radio transceiver.
- (4) **AFTER SIGHTING RESCUE AIRCRAFT:** Place ELT function selector switch in the OFF position, preventing radio interference. Attempt contact with rescue aircraft with the radio transceiver set to a frequency of 121.5 MHz. If no contact is established, return the function selector switch to ON immediately.
- (5) **FOLLOWING RESCUE:** Place ELT function selector switch in the OFF position, terminating emergency transmissions.

(6) **INADVERTENT ACTIVATION:** Following a lightning strike or an exceptionally hard landing, the ELT may activate although no emergency exists. Select 121.5 MHz on your radio transceiver. If the ELT can be heard transmitting, place the function selector switch in the OFF position; then immediately return the switch to ARM.

LOADING ARRANGEMENTS

*Arms measured to the center of the areas shown.
 ** Pilot or passenger center of gravity on adjustable seats positioned for average occupant. Numbers in parentheses indicate forward and aft limits of occupant center of gravity range.

NOTE: Station 108 or 140 can be used as a convenient interior reference point for determining the location of baggage area fuselage stations.

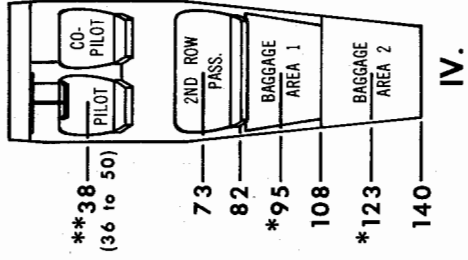
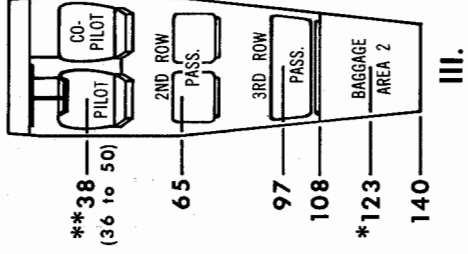
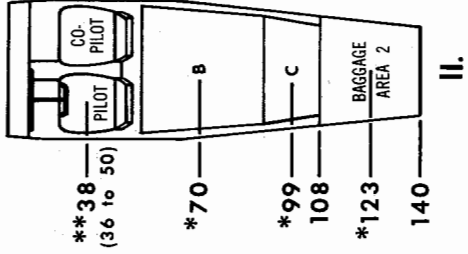
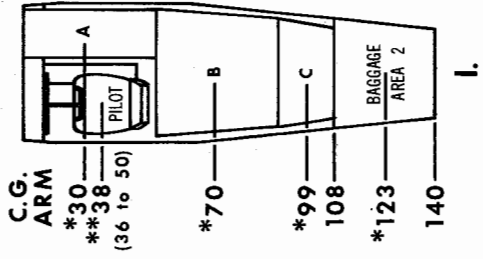
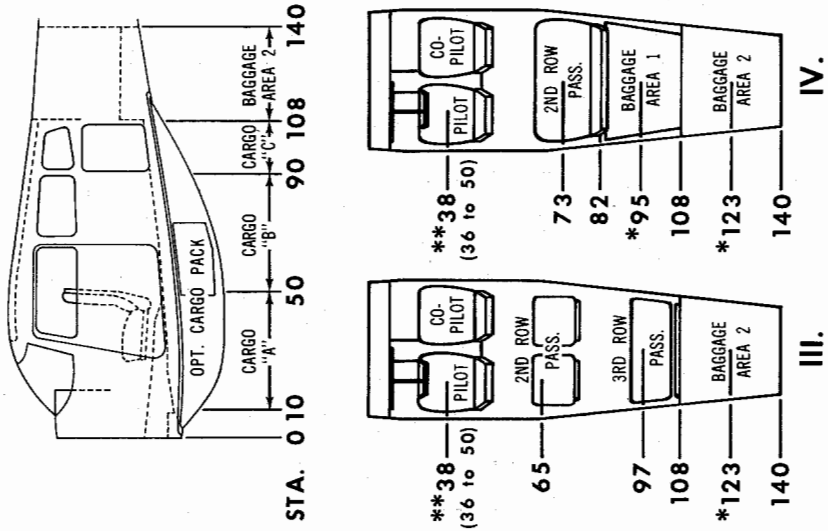

Section IV

OPERATING LIMITATIONS

OPERATIONS AUTHORIZED.

Your Cessna exceeds the requirements for airworthiness as set forth by the United States Government, and is certificated under FAA Type Certificate No. 3A24 as Cessna Model No. A185F.

The aircraft may be equipped for day, night, VFR, or IFR operation. Your Cessna Dealer will be happy to assist you in selecting equipment best suited to your needs.

Your aircraft must be operated in accordance with all FAA-approved markings and placards in the airplane. If there is any information in this section which contradicts the FAA-approved markings and placards, it is to be disregarded.

MANEUVERS — NORMAL CATEGORY.

The aircraft is certificated in the normal category. The normal category is applicable to airplanes intended for non-aerobatic operations. These include any maneuvers incidental to normal flying, stalls (except whip stalls) and turns in which the angle of bank is not more than 60°. In connection with the foregoing, the following gross weight and flight load factors apply:

Gross Weight	3350 lbs.
Flight Load Factor	
*Flaps Up	+3.8 -1.52
*Flaps Down	+2.0

*The design load factors are 150% of the above, and in all cases, the structure meets or exceeds design loads.

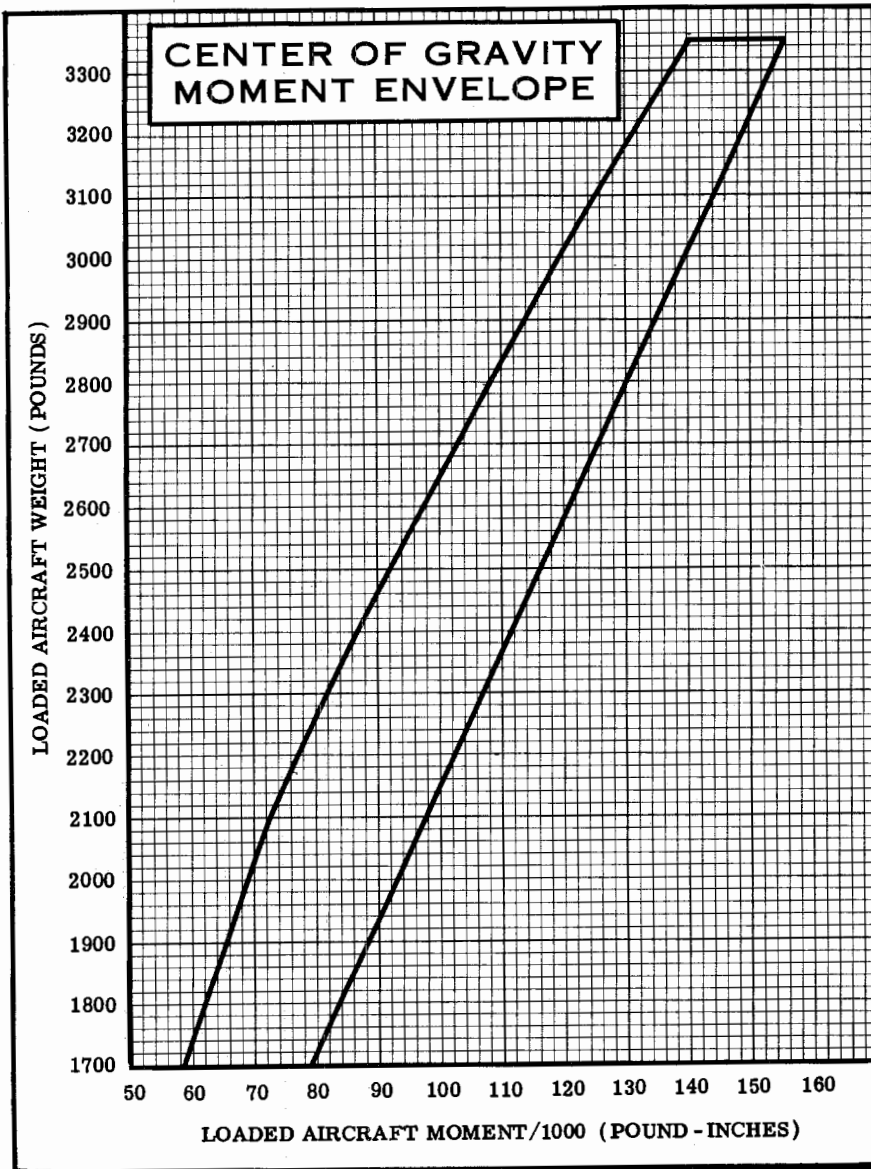

AIRSPED LIMITATIONS (CAS).

The following is a list of the certificated calibrated airspeed (CAS) limitations for the aircraft.

Never Exceed Speed (glide or dive, smooth air)	210 MPH
Maximum Structural Cruising Speed	170 MPH
Maximum Speed, Flaps Extended	110 MPH
*Maneuvering Speed	135 MPH

*The maximum speed at which you may use abrupt control travel.

AIRSPED INDICATOR MARKINGS.

The following is a list of the certificated calibrated airspeed markings (CAS) for the aircraft.

Never Exceed (glide or dive, smooth air)	210 MPH (red line)
Caution Range	170-210 MPH (yellow arc)
Normal Operating Range	68-170 MPH (green arc)
Flap Operating Range	62-110 MPH (white arc)

ENGINE OPERATION LIMITATIONS.

Power and Speed	300 BHP at 2850 RPM (5-Minute Take-Off)
	285 BHP at 2700 RPM (Maximum Continuous)

ENGINE INSTRUMENT MARKINGS.

FUEL QUANTITY INDICATORS.

Empty	E (red line)
1.5 gallons unusable each tank ("on-off" fuel system)	
3.0 gallons unusable each tank ("selector valve" fuel system)	

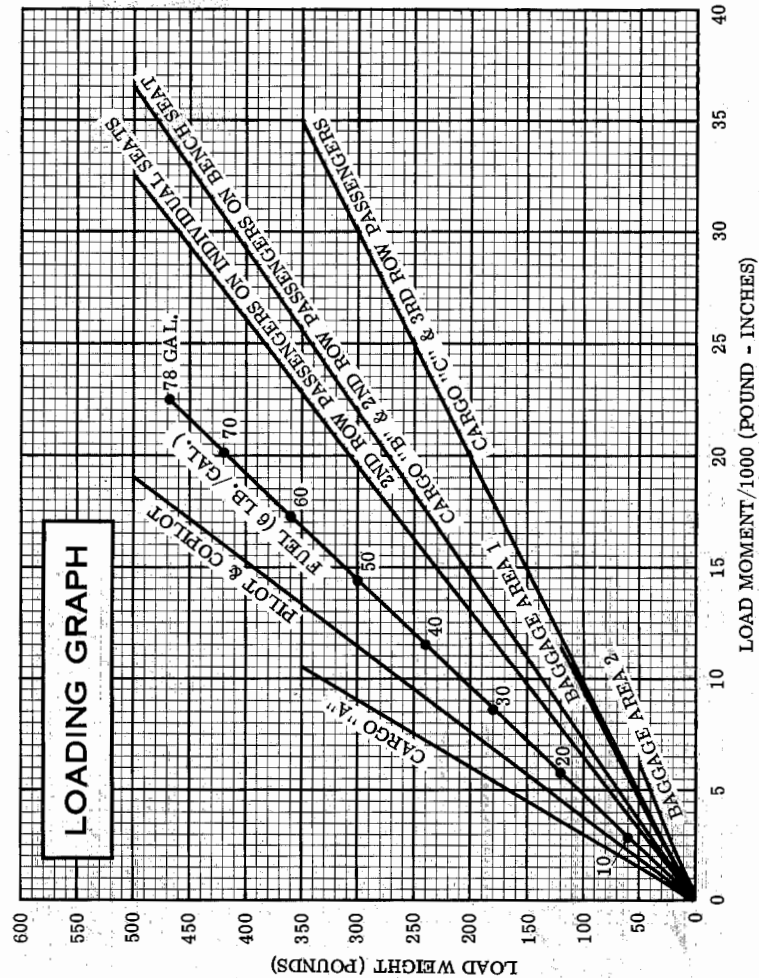

NOTES: (1) Line representing adjustable seats shows the plot or passenger center of gravity on adjustable seats positioned for an average occupant. Refer to the Loading Arrangements diagram for forward and aft limits of occupant c.g. range.
(2) Engine Oil: No Oil Filter; 12 Qts. = 22 Lbs. at -0.4 Moment/1000. With Opt. Oil Filter; 13 Qts. = 24 Lbs. at -0.4 Moment/1000.

SAMPLE LOADING PROBLEM	SAMPLE AIRPLANE		YOUR AIRPLANE	
	Weight (lbs.)	Moment (lb.-ins. /1000)	Weight (lbs.)	Moment (lb.-ins. /1000)
1. Licensed Empty Weight (Use the data pertaining to your airplane as it is presently equipped. Includes unusable fuel)	1679	60.6		
2. Oil (The weight of full oil may be used for all calculations): No Oil Filter: 12 Qts. = 22 Lbs. @ - 0.4 Moment/1000	22	-0.4		
With Opt. Oil Filter: 13 Qts. = 24 Lbs. @ - 0.4 Moment/1000				
3. Usable Fuel (At 6 Lbs/Gal.) Standard Tanks (62 Gal. Maximum)	372	17.9		
Long Range Tanks (78 Gal. Maximum)				
4. Pilot and Copilot (Sta. 36 to 50)	170	6.5		
5. 2nd Row Passengers On Individual Seats				
2nd Row Passengers On Bench Seat				
3rd Row Passengers (120 Lbs Max. If Child's Seat).				
6. *Cargo "A" (Sta. 10 to 50)	300	9.0		
*Cargo "B" (Sta. 50 to 90)	750	52.5		
*Cargo "C" (Sta. 90 to 108)	57	5.6		
Baggage Area 1 (Sta. 82 to 108, 120 Lbs. Max.)				
Baggage Area 2 (Sta. 108 to 140, 50 Lbs. Max.)				
Cargo Pack (Sta. 5 to 115, 300 Lbs. Max.)				
7. TOTAL WEIGHT AND MOMENT	3350	151.7		
8. Locate this point (3350 at 151.7) on the Center of Gravity Moment Envelope, and since this point falls within the envelope, the loading is acceptable. *Maximum allowable cargo loads will be determined by the type and number of tie-downs used, as well as by the airplane weight and C.G. limitations. Floor loading must not exceed 200 lbs per square foot.				

OIL TEMPERATURE GAGE.

Normal Operating Range Green Arc
Do Not Exceed 240°F (red line)

OIL PRESSURE GAGE.

Idling Pressure 10 psi (red line)
Normal Operating Range 30-60 psi (green arc)
Maximum Pressure 100 psi (red line)

CYLINDER HEAD TEMPERATURE GAGE.

Normal Operating Range 200-460°F (green arc)
Do Not Exceed 460°F (red line)

TACHOMETER.

Normal Operating Range. 2200-2550 RPM (green arc)
Caution Range 2700-2850 RPM (yellow arc)
Do Not Exceed (Engine rated speed). 2850 RPM (red line)

MANIFOLD PRESSURE GAGE.

Normal Operating Range. 15-25 in. Hg (green arc)

FUEL FLOW INDICATOR.

Normal Operating Range 7.0-17.0 gal/hr (green arc)
Minimum and Maximum 3.5 and 19.5 psi (25.2 gal/hr) (red line)

NOTE

A placard, located adjacent to the fuel flow indicator, provides maximum performance take-off/climb fuel flow settings at altitude. These settings, as called out on the placard, are as follows:

FUEL FLOW AT FULL THROTTLE

	2850 RPM	2700 RPM
Sea Level	24 gal/hr	23 gal/hr
4000 Feet	22 gal/hr	21 gal/hr
8000 Feet	20 gal/hr	19 gal/hr

SUCTION GAGE (GYRO SYSTEM).

Normal Operating Range 4.6-5.4 in. Hg. (green arc)

WEIGHT AND BALANCE.

The following information will enable you to operate your Cessna within the prescribed weight and center of gravity limitations. To figure weight and balance, use the Sample Loading Problem, Loading Graph, and Center of Gravity Moment Envelope as follows:

Take the licensed empty weight and moment from appropriate weight and balance records carried in your airplane, and write them down in the column titled "YOUR AIRPLANE" on the Sample Loading Problem.

NOTE

The licensed empty weight and moment are recorded on the Weight and Balance and Installed Equipment Data sheet, or on revised weight and balance records, and are included in the aircraft file. In addition to the licensed empty weight and moment noted on these records, the c. g. arm (fuselage station) is also shown, but need not be used on the Sample Loading Problem. The moment which is shown must be divided by 1000 and this value used as the moment/1000 on the loading problem.

Use the Loading Graph to determine the moment/1000 for each additional item to be carried; then list these on the loading problem.

NOTE

Loading Graph information for the pilot, passengers and baggage or cargo is based on seats positioned for average occupants and baggage or cargo loaded in the center of these areas as shown on the Loading Arrangements diagram. For loadings which may differ from these, the Sample Loading Problem lists fuselage stations for these items to indicate their forward and aft c. g. range limitation (seat travel or baggage/cargo area limitation). Additional moment calculations, based on the actual weight and c. g. arm (fuselage station) of the item being loaded, must be made if the position of the load is different from that shown on the Loading Graph. The arm for any location in the aircraft can be determined from the diagram on page 4-10 (the station is the same as the c. g. arm). Multiply the weight of the object by the arm and divide by 1000 to get the moment/1000.

NOTE

Each loading should be figured in accordance with the above paragraph. When loading is light (such as pilot and copilot, and no rear seats or cargo), be sure to check the forward balance limits. When loading is heavy (near gross weight), be sure to check the aft balance limits.

To avoid time consuming delays in cargo and/or passenger shifting, plan your load so that the heaviest cargo and/or passengers are in the forward part of the aircraft, and the lightest in the rear. Always plan to have any vacant space at the rear of the aircraft. For example, do not have passengers occupy the third row seats unless the front and second row seats are to be occupied.

Total the weights and moments/1000 and plot these values on the Center of Gravity Moment Envelope to determine whether the point falls within the envelope, and if the loading is acceptable.